

## **Historic, Archive Document**

Do not assume content reflects current scientific knowledge, policies, or practices.

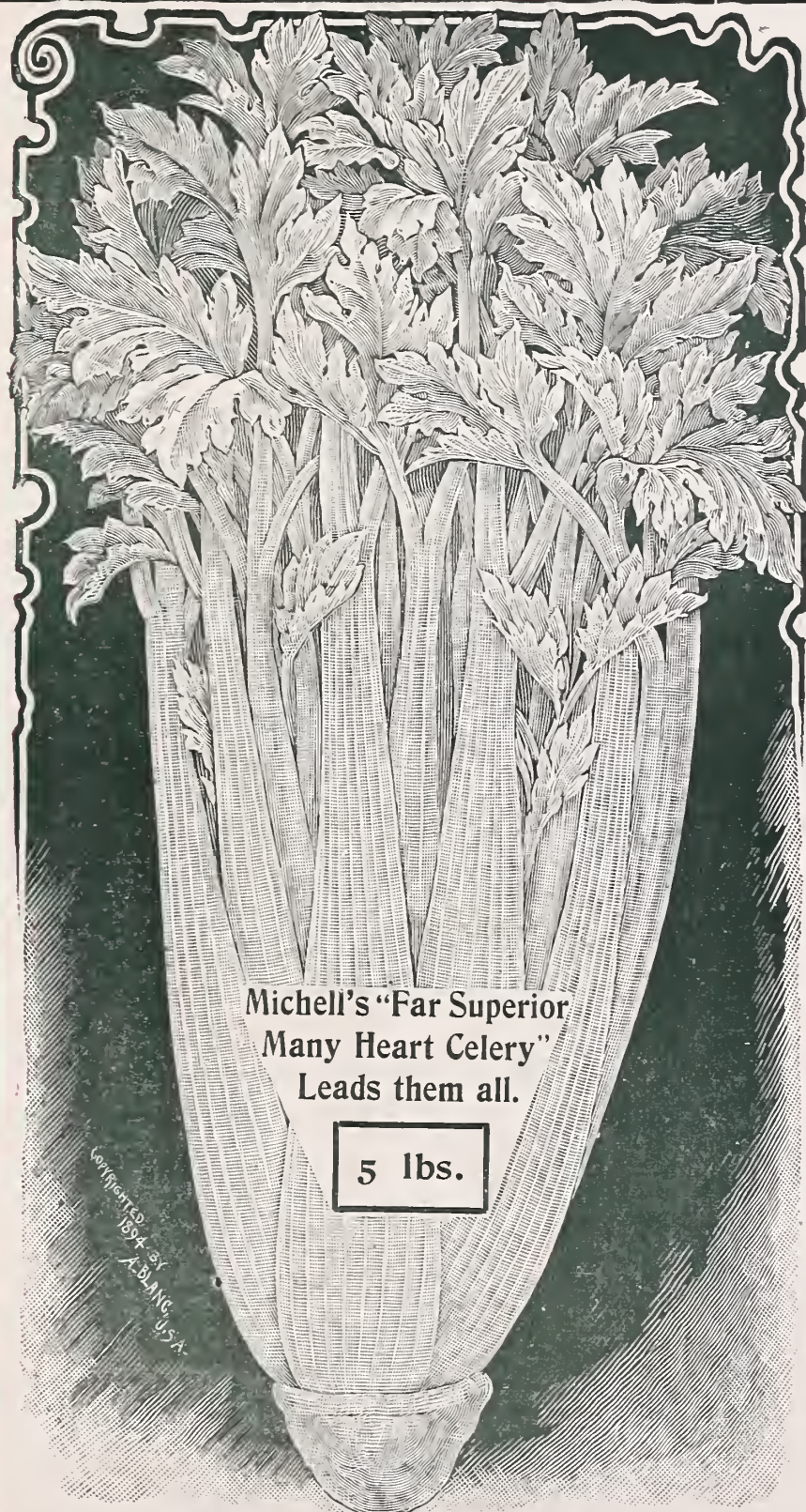

# MICHELL'S SUMMER EDITION JULY AND AUGUST 1900



MICHELL'S "Far Superior  
Many Heart Celery"  
Leads them all.

5 lbs.

MICHELL'S "FAR SUPERIOR MANY HEART."

## Celery Plants.

*Extra strong transplanted. Grown from our own seed on which customers can positively rely for the very best varieties.*

### *Michell's Far Superior Many Heart.*

We can especially recommend this variety to every grower of celery; its quality is superior to most other varieties, an excellent keeper over winter and produces plenty of heart which is now the most important point in celery.

### *White Plume.*

The best variety for early use.

### *Boston Market.*

The old reliable nutty flavor winter variety.

### *Golden Self Blanching.*

One of the best for early use, strong grower and very good flavor.

### *Dwarf Golden Heart.*

A standard favorite sort, can always be depended upon.

### *Perfection Half Dwarf.*

### *Giant Pascal.*

The largest late variety, excellent flavor.

### *Pink Plume.*

Rose color, excellent flavor.

*Price of any of the above varieties, 40c. per 100; \$3.00 per 1000.*

Special price will be quoted on larger quantities.

## Late Cabbage Plants.

### *Large Late Flat Dutch.*

True Long Island Strain. *Cannot be surpassed.*

*Strong Plants, 30c. per 100; \$2.00 per 1000.*

Telephone  
3-55-43 A.

**HENRY F. MICHELL**  
**SEEDS, PLANTS, BULBS,**  
Horticultural Supplies.  
**1018 MARKET ST., PHILAD'A.**

Henry F. Michell  
Fred. J. Michell

# POT GROWN STRAWBERRY PLANTS.

We have a large stock and assortment. The plants are now in excellent condition and will give the best of satisfaction. Pot-Grown Plants planted during July, August, and early in September, will produce a full crop of fruit next spring.

The Strawberry delights in good, rich, moist soil, but will grow on any soil which is capable of raising good general crops. By planting early, medium and late varieties, the grower is supplied with fruit during the entire Strawberry season. Plants set in late summer or fall, under favorable circumstances, will produce fruit the following season. In hill culture plant 15 inches apart each way, in beds 4 feet wide, with alleys of 2 feet between them.

We make a specialty of Strawberry Plants. Those marked (P) have pistillate or imperfect flowers, and must be planted near perfect flowering kinds, in order that the flowers may be fertilized. Plant one row of a staminate variety to every three rows of a pistillate variety.

We strongly advise using

## PURE BONE MEAL

About one tablespoonful to each plant, mix same thoroughly with the soil. You will have a finer crop of berries and the fruit will be on the plants well above the ground; the foliage will also be much healthier.

\$2.00 per 100 lbs.; \$3.50 per 200 lb sack.

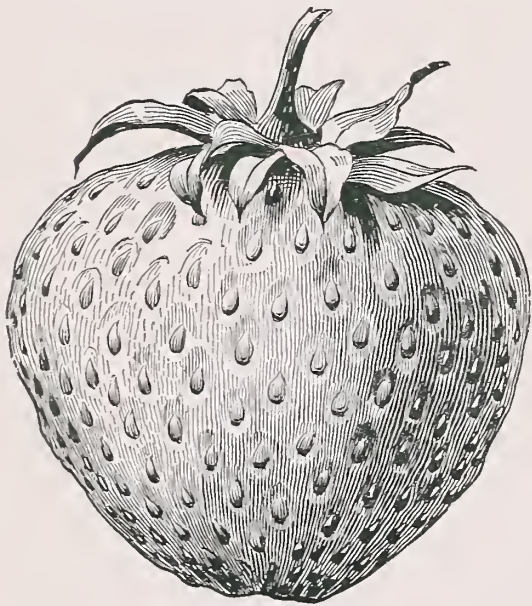

“SHARPLESS”

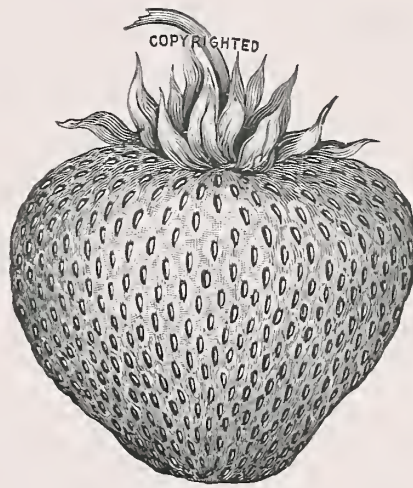

“GANDY”

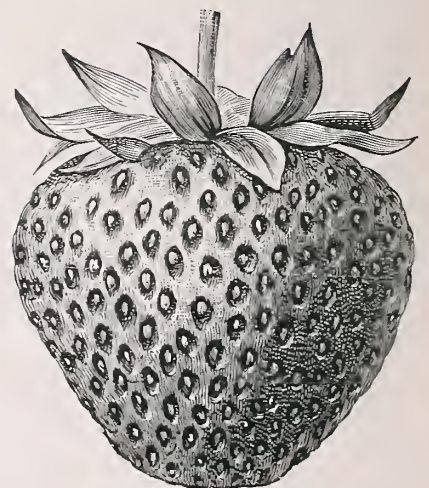

“PARKER EARLE”

Pot-Grown Plants Ready July 10th. Price \$3.00 per 100; \$25.00 per 1000.  
500 at 1000 rates.

**Brandywine.** “The plant is remarkably vigorous, of large size, hardy and healthy. It sends out many strong runners, and produces fruit in abundance, It has a perfect blossom, and its fruit colors all over. Its season is rather late, and every berry comes to maturity. The berries are very large, nearly always of regular, conical form; color bright, glossy red.”

**Bubach, (P.)** One of the best varieties we have. In productiveness unsurpassed. Noted for its uniform and large size. The plant is hardy and the leaves endure hot sun, as it is a very robust variety; does not rust. Produces berries of first quality without much care. The berry is meaty, bright red color. It will pay to plant Bubach for garden use.

**Crescent, (P.)** A very productive berry, bearing profusely. In growth it is vigorous and hardy, and produces better if the vines are not allowed to mat. They should be thinned even if a hoe has to be used. The berries are of medium size, rather tart. An excellent berry, on account of its great productiveness. A great cropper. Early.

**Cumberland Triumph.** One of the very best for home garden. Plants large, vigorous and, under rich culture, productive. The berries are very large, almost round, regular and uniform in size and shape, pale scarlet color, and of fine quality. Early to mid-summer.

**Enormous.** New, very fine, dark crimson berry. The flesh is highly colored through. Free from rust.

**Gandy.** One of the best late berries. Plant a good strong, healthy grower; berry large, firm, regular in size and shape, bright in color, handsome and showy; quality good. Season late.

**Glen Mary.** A superb variety of large size and good quality. In color a bright glossy crimson. The plant is strong and healthy, very prolific, and equaling Crescent in productiveness. Twelve specimen berries filled a quart basket. It is especially adapted to the private garden and to those who grow extra fine berries for market. Pot-grown

**Marshall.** Plant is large and strong; very prolific; 110 berries have been counted on a single plant. The fruit is handsome and attractive; very large; 14 berries have been known to fill a quart box. Perfect form; dark crimson when fully ripe, but colors all over a light crimson before ripe, and thus valuable for market; quality and flavor excellent. It will produce fruit for 25 days picking.

**Michel's Early.** This is an unusually early berry, ripening a week to ten days earlier than the Crescent. The berries are bright scarlet, conical in shape, regular, of excellent quality. It resists frost and drought on account of its strong constitution; is also free from rust. This plant has so much pollen that it is one of the best berries to fertilize all pistillate sorts.

**Parker Earle.** This is such a robust plant that it can endure hot, dry weather better than most varieties. It will thrive on light soil, is a good grower and cropper. The berries are large, firm, reddish, and in quality good; short neck, regular and uniform. Early to medium.

**Sharpless.** For the best results Sharpless requires heavy, rich soil. The plant is exceedingly large and vigorous, quite free from rust and blight. Fruit of good quality; somewhat irregular, oblong, flattened at the top.

**William Belt.** A variety of great promise. Berries large, conical, rather long, regular in outline; bright red, glossy; quality good, moderately firm; plants vigorous, healthy and quite prolific. It is of good quality, and will sell well in a fancy market.

WE CAN ALSO SUPPLY PROMPTLY ALL OTHER VARIETIES NOT ABOVE LISTED.

P. S.—We can supply very strong layer plants of any of the above standard varieties October 1st. Per 100, \$1.00; 500 for \$3.00; per 1000, \$4.00; Special prices on larger lots.



## ROSES FOR FORCING.

We have made arrangements with several of the largest rose growers to supply us with WELL-GROWN EXTRA CLEAN AND HEALTHY STOCK OF FORCING ROSES and are now able to offer them at the following prices for strictly first-class stock.

	From 3 inch Pots.	
	Per doz.	Per 100.
American Beauty . . . . .	\$1.75	\$12.00
Bride (White) . . . . .	1.50	10.00
Bridesmaid (Pink) . . . . .	1.50	10.00
Kaiserin Aug. Victoria (White) . . . . .	1.50	10.00
La France (Pink) . . . . .	1.50	10.00
Meteor (Red) . . . . .	1.50	10.00
Perle des Jardins (Yellow) . . . . .	1.50	10.00
Pres. Carnot (Flesh-White) . . . . .	1.50	10.00
Souv. de Wootton (Red) . . . . .	1.50	10.00

We are now booking orders for the New Pink American Beauty Rose, "QUEEN OF EDGELY," which will be ready March 1st, 1901. All orders will be filled in strict rotation.

### Asparagus Plumosus Plants.

3 inch pots, 15c. each; \$1.50 per doz.; \$10.00 per 100.  
4 inch pots, 25c. each; \$2.50 per doz.; \$18.00 per 100.

### Asparagus Sprengeri Plants.

3 inch pots, 15c. each; \$1.50 per doz.; per 100, \$10.00.  
4 inch pots, 25c. each; \$2.50 per doz., per 100, \$18.00.

### Smilax Plants.

2½ inch pots, 10c. each; \$1.00 per doz.; per 100, \$5.00.

## CHOICEST FERNS.

Desirable varieties special for filling fern dishes or pans or for decorative purposes. 2½ inch pots, per doz., \$1.00; per 100, \$7.50. 3 inch pots, per doz., \$1.25; per 100, \$10.00.

Also ARAUCARIAS, FICUS, Etc., Etc.



## Palms

Grown in Cool greenhouses, preferable and more satisfactory than those grown in Hot houses.

### Kentias.

	Each.
15 inch high, 5 to 6 leaves . . . . .	\$1.00
20 inch high, 6 to 7 leaves . . . . .	1.50
24 to 30 inch high, 6 to 7 leaves . . . . .	2.00

Also larger sizes, from \$2.50 to \$5.00 each.

### Latantias (Fan Leaved Palm.)

	Each.
5 to 6 leaves, 15 inches high . . . . .	\$0.50
6 well developed leaves, 15 inches high . . . . .	1.00
6 to 7 well developed leaves, 20 inches high . . . . .	1.50

Also larger sizes, from \$2.00 to \$5.00 each.



## Ferns

### The New Boston Fern.

Without exception the most desirable fern. It is very easily kept in the house, and grows into fine, graceful, fountain shape specimens.

	Each.	Per doz.
Good young plants . . . . .	\$0.25	\$2.50
Strong plants . . . . .	.50	5.00
Large plants . . . . .	1.00	10.00

Specimen plants, \$2.00 to \$5.00 each.

# BULBS FOR EARLY PLANTING. FORCING.

L  
I  
L  
I  
U  
M

H  
A  
R  
R  
I  
S  
I  
I



PHOTOGRAPH OF A HOUSE FULL OF EASTER LILIES (LIL. HARRISII), TAKEN APRIL 9TH, 1900. GROWN BY H. I. FAUST, MERION STA., PA. ALL BULBS SUPPLIED BY US.

Merion, Montgomery Co., Penna., 14th day of April, 1900.

Mr. HENRY F. MICHELL, Seedsman, Etc.:

My Dear Sir:—I cannot refrain from congratulating you, as well as myself, upon the outcome of Harrisii Lilies purchased from you last August.

They were the most satisfactory we have had for years. Out of 3800 bulbs we had 5500 salable plants. Please book me same quantity for next season, With kind regards, believe me,

Very truly yours,

HENRY I. FAUST.

Trenton, N. J., April 16th, 1900.

Mr. HENRY F. MICHELL,

Dear Sir:—Your lilies turned out the best I ever saw. The loss on them was only ABOUT TWO PER CENT. The flowers on them were from eight to fourteen on each plant. Please book me fifteen hundred more for next year.

Yours truly,

CARL E. TAUBE.

## Lilium Harrisii.

BERMUDA  
EASTER LILY.

Size of Bulbs.	Each.	Per doz.	Per 100.
5 to 7 inch . . . . .	\$0.10	\$1.00	\$7.00
7 to 9 inch . . . . .	.20	2.25	15.00
9 to 11 inch . . . . .	.40	4.00	30.00
11 to 13 inch . . . . .	.75	7.50	60.00

## Lilium Longiflorum.

(BEST BERMUDA  
GROWN.)

Size of Bulbs.	Each.	Per doz.	Per 100.
5 to 7 inches . . . . .	\$0.10	\$1.00	\$7.00
7 to 9 inches . . . . .	.20	2.25	15.00
9 to 11 inches, extra large . . . . .	.40	4.00	30.00

## Lilium Candidum.

(ST. JOSEPH'S  
LILY.)

First size bulbs, 15c. each; \$1.25 per doz.; \$6.50 per 100.

## White Calla Lily.

They flourish best in a warm, damp place, and require plenty of water after the leaves have formed. Pot the bulbs in September; give but little water until November. First size bulbs, each 15 cts., per doz. \$1.50; extra size bulbs, each 20 cts., per doz. \$2.00; monster size bulbs, 30 cts. each; \$3.00 per doz.

## Spotted Foliage Calla Bulbs.

10 cts. each; \$1.00 per doz.; \$7.00 per 100.

## Freesias.

REFRACTA  
ALBA.

First size bulbs, 15 cts. per doz., 75 cts. per 100, \$6.00 per 1000.  
Mammoth bulbs, 20 cts. per doz., \$1.50 per 100.  
Monster size bulbs, 35 cts. per doz., \$2.25 per 100.

## French Roman Hyacinths.

Specially adapted for forcing in greenhouse or growing in the house. Very showy when planted in a window box or in six or seven inch pots, three or four bulbs in a pot.

	Each.	Per doz.	Per 100.	Per 1000.
Pure White. 12 to 25 ctm. bulbs,	\$0.04	\$0.35	\$2.50	\$20.00
" " Mammoth bulbs . . . . .	.05	.45	3.00	25.00
" " Giant bulbs . . . . .	.06	.55	4.00	35.00
Pink . . . . .	.04	.30	2.00	19.00
Blue . . . . .	.04	.30	2.00	19.00
Italian. White. Larger spikes and later blooming than the French . . . . .	.04	.30	2.00	19.00

## Allium.

NEAPOLITANUM.

3 cts. each; 20 cts. per doz.; \$1.00 per 100; \$7.50 per 1000.

## Narcissus.

Paper White Multiflora. (Extra.) 40 cts. per doz.; \$2.50 per 100; \$20.00 per 1000.

Paper White Grandiflora. Very large flowering, the favorite forcing variety, superior to the old sort, specially desirable for cutting. Per doz. 30 cts.; per 100 \$1.75; per 1000 \$14.00.

Double Roman. (Polyanthus). Clusters of double white flowers with yellow centre; an excellent variety for forcing. Each, 3 cts.; per doz. 25 cts.; per 100 \$1.75; per 1000 \$12.00.

## New French Paris Market Double Yellow Von Sion.

For Christmas forcing. Every gardener should plant a quantity of these, they will be novel and satisfactory. 40 cts. per doz.; \$2.75 per 100; \$20.00 per 1000.

# DUTCH BULBS, Hyacinths, Daffodils, Ready in September Tulips, Crocus, Etc.

NEW CROP  
JUST RECEIVED

## FLOWER SEEDS

NEW CROP  
JUST RECEIVED

## BROWALLIA.

**Speciosa Major.** A beautiful new large-flowering variety of the most brilliant ultramarine blue, a rare color; especially desirable as a pot plant for Winter and early Spring, flowering either in conservatory or greenhouse. 10 cts. per pkt.

## CALCEOLARIA.

An ornamental plant and a universal favorite for decorating the greenhouse or conservatory.

**Sutton's Perfection, Choicest Mixed.** Per original pkt., 75 cts.

**James' Superb Strain, Choicest Mixed.** Pkt., 50 cts.

**Hybrida Grandiflora, Tall Mixed.** Large flowering, completely covered with beautiful rich, self-colored flowers, saved from choice collections; all colors. Pkt., 25 cts.

**Hybrida Grandiflora Pumila Compacta.** Dwarf, compact, robust growth, producing immense trusses of large and varied brilliant self-colored and spotted flowers; one foot high. Pkt., 40 cts.

**Rugosa, Mixed.** (*Shrubby*). Small flowering varieties for bedding; of finest colors; two feet high. Pkt., 50 cts.

CAMPANULA (*Canterbury Bells*)

199 **Choice Mixed Double.** Pkt., 5 cts.; 50 cts. per oz.

200 **Choice Mixed Single.** Pkt., 5 cts.; 30 cts. per oz.

201 **Cup and Saucer** (*Calycanthema*). Most beautiful varieties; choice mixed. Pkt., 10 cts.

202 **Cup and Saucer.** Pure white. Pkt., 10 cts.

203 **Persicifolia Blue.** Beautiful species. Suitable for greenhouse. Pkt., 15 cts.

204 **Persicifolia White.** Beautiful species. Suitable for greenhouse. Pkt., 15 cts.

## CINERARIA.

Strain finest to be had; size of flowers immense; color and shape most perfect. No flower measures less than six inches in circumference; majority of them much larger. The Silver Dollar size is eclipsed by this magnificent strain.

**Michell's Large Flowering Prize Dwarf.** Best sort as a pot plant. Per pkt., 35 cts.; 3 pkts. for \$1.00.

**Michell's Large Flowering Prize, Medium Tall.** Desirable to grow as a decorative plant, also for cutting. Per pkt., 35 cts.; 3 pkts. for \$1.00.

**Sutton's Superb, Mixed Colors.** Per original pkt., 60 cts.

**James' Superb Choicest Strain, Mixed Colors.** Pkt., 50 cts.



Michell's Giant Prize Cineraria.

**Michell's Large Flowering Crimson.** Per pkt., 40 cts.

**Michell's Large Flowering White.** Per pkt., 40 cts.

**Michell's Large Flowering Blue.** Per pkt., 40 cts.

**Choice Mixed Hybrida.** Per pkt., 25 cts.

**Choicest Double Mixed.** Beautiful. Per pkt., 50 cts.

**Stellata** (*Sutton's*). New and very desirable as a pot plant or for cutting. Original pkt., \$1.25.

## GLOXINIA.

**Sutton's Prize Mixture.** Per original pkt., 60 cts.

**International Mixture.** The best strain in existence, embracing all the choicest self and tigered flowers. Pkt., 25 cts.

## HOLLYHOCK.

This strain is of the very best, saved from the most double flowers by a specialist. Sow seeds in July and August to have strong blooming plants for next summer.

**"Allegheny"**. Fringed perpetual blooming. Pink. Pkt., 15 cts.

**"Allegheny"**. Fringed perpetual blooming. Rich scarlet. Pkt., 15 cts.

**"Allegheny"**. Fringed perpetual blooming. Choicest mixed. Pkt., 15 cts.

**Snowball.** Pure white, very double. Per pkt., 10 cts.; per oz., \$1.25.

**Bright Red.** Per pkt., 10 cts.; per oz., \$1.25.

**Yellow.** Per pkt., 10 cts.; per oz., \$1.25.

**Pink.** Per pkt., 10 cts.; per oz., \$1.25.

**Choice Mixed.** Per pkt., 10 cts.; per oz., \$1.00.

**Collections.** Imported. Containing twelve separate colors, \$1.00.

**Collections.** Imported. Containing six separate colors, 50 cts.



New Hollyhock "Allegheny".

## DOUBLE DAISY (*Bellis Perennis*).

Sow in August and September and treat similar to Pansies.

**New Double Giant White.** Extra large and very double. Per pkt., 15 cts.; 4 pkts. for 50 cts.

**New Double Giant Mixed.** Contains the red and white. Per pkt., 15 cts.; 4 pkts. for 50 cts.

**Snowball.** Best white from seed; very double. Per pkt., 10 cts.

**Longfellow Red.** Double. Per pkt., 10 cts.

**Choicest Double Mixed.** Per pkt., 10 cts.

## MIGNONETTE.

**Mignonette "Nineteenhundred".** The plant forms a semi-globular bush of the most perfect shape, measuring 24 inches in diameter and consisting often of more than 400 flowerspikes. It will be no exaggeration to say that anything more perfect in regularity of shape of the plant and in over-abundance of flowers could not be imagined in a Mignonette. 25 cts. per original pkt.; 3 pkts. for 60 cts.

**Sutton's Giant.** Per original pkt., 25 cts.

**Allen's New Defiance.** Specially adapted for growing under glass. When grown under favorable conditions and with proper care, its spikes will not only be of remarkable size, from 12 to 15 inches long, but deliciously fragrant. Pkt., 10 cts.; per 1/8 oz., 25 cts.

**Bird's Mammoth.** Very large spikes. Pkt., 10 cts.; oz., 50 cts.

**Machet.** Improved. Per pkt., 10 cts.; per oz., 75 cts.

## FORGET=ME=NOT (*Myosotis*).

**Alpestris Victoria.** Of bushy habit, bearing large bright-blue flowers. The plant attains a diameter of 8 to 10 inches, and when fully grown is globular in shape and perfectly covered with flowers. Pkt., 10 cts.; 1/8 oz., 50 cts.

**Alpestris Cœrulea (Alpine).** Bright blue. Pkt., 10 cts.

**Eliza Fanrobert.** The most robust grower; specially adapted for outdoor growing; flowers very large, blue. Pkt., 10 cts.; per 1/8 oz., 25 cts.

**Dissitiflora.** Compact habit; pinkish blue. Pkt., 10 cts.

**Palustris Semperflorens.** The most desirable sort for cutting or greenhouse use. Pkt., 10 cts.

**"Nixenauge".** The real Forget-Me-Not. The flowers are as large as those of *Dissitiflora* "Perfection" but of greater duration, beautiful sky blue and on long stems. The treatment is the same as *Myosotis Alpestris*. Pkt., 10 cts.

## POPPY==Perennial Sorts.

This class of poppies has become one of the most popular flowers of late, so that no garden is complete without them. Seeds can be sown in August and September in the open ground and they will bloom early the following summer.

**Iceland Mixed.** The colors range from the purest white and yellow to the deepest glowing orange scarlet, and have a delicious fragrance. The profusion of flowers is really astonishing. They are very fine cut flowers and will last a week if cut as soon as they are open. Mixed colors. Pkt., 10 cts.; 3 pkts. for 25 cts.

**Oriental Hybrids.** Choice mixed. Pkt., 10 cts.

**Giant Orange.** Pkt., 10 cts.; 3 pkts. for 25 cts.

**Giant Scarlet.** Pkt., 10 cts.; 3 pkts. for 25 cts.

**Collection** of eight varieties. Each color separate, 40 cts.

## NEW PANSY 'MASTERPIECE'

**New Giant-Curled Pansy.** 25 cts. per original pkt.; 5 pkts. for \$1.00.

## PANSIES.



Michell's Giant Exhibition Pansies.

MR. MICHELL,

Dear Sir:—I am pleased to inform you that from one packet of Michell's Giant Exhibition Pansy I raised about 900 plants, producing extra large flowers of the most beautiful shades of color. Everyone who has seen them say they never saw such a fine strain of Pansies; always sure to ask where such a fine strain of seed could be procured. Yours truly,

GEO. M. HAY.

**Michell's Giant Exhibition Pansy, Mixed.** A strain which we have secured from one of the leading pansy specialists in Germany to which we added the cream of the Paris strain, also the choicest to be had from Scotland. It can be relied upon to give flowers of immense size, very heavy texture, and of the most brilliant colors. Per pkt., 25 cts.; per 1/8 oz., \$1.00; per oz., \$6.00.

**New French Large Stained.** Choicest mixed. Pkt., 25 cts.

**Bugnot's Giant French Mixed.** Per pkt., 25 cts.; per 1/4 oz., \$2.50.

**Cassier's Strain, Odier.** Of very large blotched flowers in mixture. Per pkt., 25 cts.; per 1/4 oz., \$2.00.

**Giant Prize.** Black blue . . . . . Pkt., 25 cts.; 1/8 oz., 50 cts.

" " Azure blue . . . . . " " "

" " Lord Beaconsfield . . . . . " " "

" " Striped and Mottled . . . . . " " "

" " White with Eye . . . . . " " "

" " Snowflake, Pure White . . . . . " " "

" " Yellow with Eye . . . . . " " "

" " Brown and Red . . . . . " " "

**Trimardeau.** Choicest mixed. Per pkt., 15 cts.; per oz., \$3.00.

**Snow Queen.** Largest white. Per pkt., 10 cts.; per oz., \$1.25.

**Faust.** Black. Per pkt., 10 cts.; per oz., \$1.00.

**Yellow Gem.** Per pkt., 10 cts.; per oz., \$1.25.

**Emperor William.** Per pkt., 10 cts.; per oz., \$1.00.

**Lord Beaconsfield.** The best rich violet. Per pkt., 10 cts.; per oz., \$1.25.

**Striped.** Per pkt., 10 cts.; per oz., \$1.00.

**Havana Brown.** Per pkt., 10 cts.

**Purple.** Silver edged. Per pkt., 10 cts.; per oz., \$1.00.

**Gold Margined.** Per pkt., 10 cts.; per oz., \$1.00.

**Silver Edged.** Per pkt., 10 cts.; per oz., \$1.00.

**Very Large Flowering.** Choicest mixed. Per pkt., 10 cts.; per oz., \$1.50.

**Choice Mixed.** First quality. Per pkt., 5 cts.; per oz., 75 cts.

**Collection.** Containing 6 pkts., in six colors, 40 cts.

**Collection.** Containing 12 pkts., twelve colors, 75 cts.



**PRIMULA.****Sinensis Fimbriata—Chinese Primrose.****Michell's Prize Mixture.** Grown by a Primula specialist, who has received prizes wherever exhibited. Pkt., 25 cts.;  $\frac{1}{2}$  oz., \$1.00.  
**Williams' Superb Strain.** The finest English Mixture. Pkt., 40 cts.**Sutton's Giant Mixed.** Fringed. \$1.25 per original pkt.**Fern Leaved.** Choicest mixed. Pkt., 25 cts.**Kermessina Splendens.** Brilliant red with yellow centre. Pkt., 25 cts.**Holborn Blue.** Fully 50 per cent. will come blue. Pkt., 40 cts.**Alba Magnifica.** Very large white flowers. Pkt., 40 cts.**Stellata (Sutton's).** New, very handsome, excellent as a pot plant or for cutting. Per original pkt., \$1.25.**DOUBLE CHINESE PRIMROSE.****Pure White.** Pkt., 50 cts.**Choice Mixed.** Pkt., 50 cts.**ENGLISH GREENHOUSE PRIMULAS.****Forbesi (Baby Daisy).** The freest flowering Primula grown. The seed germinates very quickly, and the little plants throw up tiny flower stalks when only a few weeks old. These, however, should be pinched off, and the plants kept growing until October, when the flowers may be allowed to develop, and from then on until late in the spring they produce their sprays of beautiful pinkish flowers in the greatest profusion. Pkt., 25 cts.**Obconica Grandiflora.** Flowers much larger than old variety. Pkt., 15 cts.**Obconica Grandiflora Rosea.** New Pink. Pkt., 15 cts.**Floribunda.** Beautiful and fragrant; yellow. Pkt., 25 cts.**HARDY PRIMROSE.****Primula Veris (English Cowslip).** Flowers of different colors; yellow, brown and yellow edged, etc.; very fragrant. Pkt., 10 cts.**Primula Vulgaris.** The common hardy English variety; light canary yellow color. Pkt., 10 cts.**PHLOX.****Hardy (Phlox Decussata).** These rank among the finest herbaceous perennials for beds and borders; mixture of the finest flowers. Per pkt., 10 cts.; per  $\frac{1}{4}$  oz., 40 cts.**SWEET WILLIAM (Dianthus Barbatus).**A well-known plant which has been greatly improved of late years, producing splendid effect in beds and shrubbery; hardy perennial;  $1\frac{1}{2}$  feet high.**Auricula-Flowered, Mixed.** A beautiful class of "eyed" single varieties, all colors. Per pkt., 5 cts.; per oz., 40 cts.**Double Mixed.** The finest colors saved from a splendid double collection. Per pkt., 10 cts.; per oz., \$1.00.**WALLFLOWER.****Single Mixed.** All colors. Pkt., 5 cts.**Finest Double Mixed.** All colors. Pkt., 10 cts.**Collection.** Containing eight double varieties; each separate. Pkt., 50 cts.**Vegetable Seeds for Summer Sowing.****BEETS (Varieties for Table Use).**

One ounce will sow fifty feet of drill.

**Bastian's Extra Early Turnip.** Oz., 10 cts.; 1 lb., 50 cts.**Crosby's Egyptian.** Oz., 10 cts.; 1 lb., 60 cts.**Bastian's Half-Long Blood.** Oz., 10 cts.; 1 lb., 50 cts.; 5 lbs., \$2.00.**ALSO ALL OTHER VARIETIES.****MANGEL=WURZEL BEET.**

Five pounds are sown to the acre.

Sow in thoroughly plowed, well-manured soil, in drills two inches deep and about eighteen inches apart. Thin out to twelve inches and keep the weeds down by frequent hoeing and cultivating. Low ground is best adapted for mangel-wurzels.

**Mammoth Long Red.** This is an enormously productive variety, yielding from fifty to seventy tons to the acre, a single root often weighing from twenty to thirty pounds. It is the best long red mangel and very valuable for stock feeding. Oz., 5 cts.; lb., 30c.; 10 lb. lots, \$2.50.**Golden Tankard.** Oz., 5 cts.; lb., 30 cts.; 10 lb. lots, \$2.50.**Red Globe.** Oz., 5 cts.; lb., 30 cts.; 10 lb. lots, \$2.50.**Yellow Globe.** Oz., 5 cts.; lb., 30 cts.; 10 lb. lots, \$2.50.**Norbiton Giant.** Oz., 5 cts.; lb., 30 cts.; 10 lb. lots, \$2.50.**BEANS (Dwarf or Snap Short).**

One quart will plant 200 hills or a drill 100 feet long.

**Improved Extra Red Valentine.** Qt., 30 cts.; 4 qts., \$1.00; pk., \$1.90.**Dwarf Golden Wax (Rust Proof).** Qt., 30 cts.; 4 qts., \$1.00; pk., \$1.90.**Wardwell's Kidney Wax.** Qt., 30 cts.; 4 qts., \$1.00; pk., \$1.90.**Black or German Wax.** Qt., 30 cts.; 4 qts., \$1.00; pk., \$1.90.**ALSO ALL OTHER VARIETIES.****CAULIFLOWER.****Michell's Snowstorm.** Extra early. Pkt., 25 cts; per oz., \$5.00.**Selected Erfurt (True).** Pkt., 20 cts; per oz., \$2.50.**Sutton's First Crop.** Per original pkt., 50 cts.**ALSO ALL OTHER VARIETIES.****CUCUMBER.**

One ounce of seed will plant about 50 hills, or two pounds per acre.

**Improved Early White-spined.** Pkt., 5 cts.; oz., 10 cts.; lb., 75 cts.**Jersey Pickle, or Green Prolific.** Pkt., 5 cts; oz., 10 cts.; lb., 75 cts.**SWEET, or SUGAR CORN.**

One quart will plant 100 hills, 8 quarts to the acre.

**Crosby's Extra Early.** **Stabler's Extra Early.** **Squantum.****Triumph.** **Little Gem, or Shoe Peg.** **Black Mexican.****Stabler's Nonpareil.** **Country Gentleman.** **Roslyn Hybrid.****Egyptian.** **Mammoth Sugar.** **Stowell's Evergreen.****Any of the above varieties, 20 cts. per qt.; 4 qts., 60 cts.; \$1.00 per pk.****ENDIVE.****Green Curled.** Pkt., 5 cts.; oz., 20 cts.**Giant Fringed.** Pkt., 5 cts.; oz., 20 cts.**White Curled.** Pkt., 5 cts.; oz., 20 cts.**LETTUCE.****Michell's "All Right".** Pkt., 10 cts.; oz., 25 cts.;  $\frac{1}{4}$  lb., 75 cts.**Forcing Emperor.** Pkt., 5 cts.; oz., 20 cts.;  $\frac{1}{4}$  lb., 50 cts.**Early Tennisball.** Pkt., 5 cts.; oz., 15 cts.;  $\frac{1}{4}$  lb., 40 cts.**Boston Market.** Pkt., 5 cts.; oz., 15 cts.;  $\frac{1}{4}$  lb., 40 cts.**Early Dutch Butter Spotted.** Pkt., 5 cts.; oz., 20 cts.;  $\frac{1}{4}$  lb., 50 cts.**Early Cabbage, or White Butter.** Pkt., 5 cts.; oz., 15 cts.;  $\frac{1}{4}$  lb., 40 cts.; 1 lb., \$1.25.**ALSO ALL OTHER VARIETIES.****PARSLEY.**

One ounce sows about 100 feet of drill.

Seed germinates very slowly, plants sometimes not appearing for three or four weeks; soak seed a few hours in lukewarm water before sowing.

**Double Curled Covent Garden.** Finely curled dwarf. Pkt., 5 cts.; oz., 10 cts.;  $\frac{1}{4}$  lb., 25 cts.; lb., 75 cts.**Extra Curled Perpetual.** Leaves tender, crimped and very curly; excellent for garnishing. Pkt., 5 cts.; oz., 10 cts.;  $\frac{1}{4}$  lb., 25 cts.; lb., 75 cts.**Fern Leaved.** Valuable for garnishing. Pkt., 5 cts.; oz., 10 cts.;  $\frac{1}{4}$  lb., 25 cts.; lb., 90 cts.**New Perfection Curled.** Per pkt., 10 cts.**Sutton's Garnishing.** Per pkt., 25 cts.**Champion Moss Curled.** Beautifully crimped and curled. It can be cut the year round, rarely runs to seed. Pkt., 5 cts.; oz., 10 cts.;  $\frac{1}{4}$  lb., 25 cts.; lb., 90 cts.

**PEAS.**

One quart to 100 feet of row.

Dandy Extra Early. Pt., 15 cts.; qt., 25 cts.; pk., \$1.25; bush., \$4.00.  
ALSO ALL OTHER VARIETIES.

**SPINACH.**

Victoria (Long Standing). Oz., 10 cts.; lb., 35 cts.

Bloomsdale Savoy. Oz., 10 cts.; lb., 35 cts.

New Zealand. Oz., 10 cts.; lb., 80 cts.

New Crop.



Purple Top  
Ruta Baga.

## TURNIP and RUTA BAGA SEED

One ounce for 100 feet, two pounds to the acre.

**Early White Flat Dutch.** An early white fleshed variety of quick growth, mild flavor and excellent quality. Pkt., 5 cts.; oz., 10 cts.;  $\frac{1}{4}$  lb., 15 cts.; lb., 40 cts.; 2 lbs., 70 cts.

**Early White Egg.** Pkt., 5 cts.; oz., 10 cts.;  $\frac{1}{4}$  lb., 15 cts.; lb., 50 cts.

**Early Red or Purple Top, Flat (Strap-leaved).** Top is red or purple; flesh red-grained, of mild flavor and a good keeper. Pkt., 5 cts.; oz., 10 cts.;  $\frac{1}{4}$  lb., 15 cts.; lb., 40 cts.; 2 lbs., 70 cts.

**Purple Top, White Globe.** Either for table or stock; is a heavy producer, early, of rapid growth and an excellent keeper. Pkt., 5 cts.; oz., 10 cts.;  $\frac{1}{4}$  lb., 15 cts.; lb., 40 cts.; 2 lbs., 70 cts.

**Yellow Globe or Amber.** One of the best for general crop; excellent for table use or feeding stock; keeps well until late in the spring. Pkt., 5 cts.; oz., 10 cts.; lb., 40 cts.; 2 lbs., 75 cts.

**Improved Yellow Purple Top Ruta Baga or Swedish Turnip.** The leading variety grown for stock as well as for family use; flesh yellow, solid, sweet, fine-grained and good flavor. Pkt., 5 cts.; oz., 10 cts.;  $\frac{1}{4}$  lb., 15 cts.; lb., 50 cts.; 2 lbs., 90 cts.

**MUSHROOM SPAWN.**

"Michell's Always Reliable" English Milltrack. We receive fresh shipments from England every month. We supply a number of the leading and largest growers of Mushrooms with our Superior Spawn, and have received a large number of testimonials of its high quality. 15 cts. per brick; \$1.75 per doz. bricks; 25 lbs. for \$2.50; \$8.00 per 100 lbs. Special price for larger quantities. (Directions for growing free).

We offer \$5.00 in 2 Prizes for the best dish of Mushrooms exhibited at the Philadelphia Chrysanthemum Show, November, 1900.

Wm. Falconer's Book on Mushroom Culture, Price \$1.35.

Robinson's Book on Mushroom Culture, Price 50 cts.

Practical Mushroom Culture (Complete and New).

FREE TO APPLICANTS.



Michell's Mushroom Spawn.

**LAWN GRASS SEED.**

**Michell's "None-Superior Evergreen" Lawn Grass Seed.** This mixture is made of the finest varieties, presenting the appearance of the lawn like a bed of dark green velvet. We can safely say that there is no better mixture in the market. The seeds used are all fresh and re-cleaned, and enough white clover is added to make it strong and durable. Qt., 25 cts.; pk., \$1.00; bush. (20 lbs.), \$4.00; 5 to 10 bush. lots, \$3.75. *Please note that we give 20 lbs. to the bush., which is nearly  $1\frac{1}{4}$  bushels.*

**Fairmount or Central Park Lawn Mixture.** A very fine mixture, which we can highly recommend. Qt., 20 cts.; pk., 75 cts.; bush. (15 lbs.), \$2.75; 5 to 10 bush. lots, \$2.50 bush.

**Phila. Country Club Golf Grounds Mixture.** P. F. Poy's special formula. Strictly reliable. \$2.50 per bush.; 5 bush. lots at \$2.25 per bush. Special price on application for larger quantities.

**Michell's Lawn Tennis Mixture.** Contains a special mixture of short-growing varieties. Bu. of 20 lbs., \$4.00

**Golf Greens Mixture.** This is a new mixture of our own, made up especially from such grasses as will grow very short and make a solid surface to withstand heavy wear. Bush. of 20 lbs., \$4.00. Special price on quantity.

Also all other Varieties.

**CLOVER AND TIMOTHY SEED.**

**White Dutch Clover.** The best variety for lawns; remains green throughout the season; highest grade of seed only. Lb., 25 cts.; 10 lb. lots, 20 cts. lb.; 100 lbs., \$18.00.

**Alsike or Swedish.** Valuable for pasturage or ensilage. Lb., 25 cts.; 100 lbs., \$11.00.

**Alfalfa or Lucerne.** Sow early in spring to secure a good stand before winter. Lb., 15 cts.; bush. (60 lbs.), \$6.00; \$9.00 per 100 lbs.

**Scarlet or Crimson Clover.** Lb., 10 cts.; bush., \$4.75; \$7.50 per 100 lbs.

**Timothy Seed.** Extra prime, choicest quality, free from weeds. About \$1.75 per bu.

**MILLET SEED (Prices Fluctuate).**

**German or Golden Millet.** Qt., 15 cts.; bush. (48 lbs.), \$1.35.

**Hungarian Millet.** Qt., 15 cts.; bush. (48 lbs.), \$1.00.

THE VERY BEST.  
STRICTLY FREE FROM WEEDS  
A Few Specialties:

# ❖ POULTRY SUPPLIES ❖

- Animal Meal.** (Bowker's.) 5 lbs. for 20c.; 10 lbs. 40c.; 25 lbs. 75c.; 50 lbs., \$1.25; 100 lbs. \$2.25.
- Barley.** Per qt. 15c.; bush. \$1.00.
- Bone (Granulated).** The use of ground bone tends to keep fowls in good health, and materially aids laying hens. 5 lb. pkge. 20c.; 25 lbs. \$1.00; 100 lbs. \$2.25; 200 lb. bag \$4.00.
- Buckwheat.** For Pigeons and young poultry. Per qt. 10c.; peck 30c.; bush. \$1.00.
- Clover Meal (Pioneer).** Best quality. 5 lbs. 25c.; 25 lbs., 75c.; 50 lbs. \$1.00; 100 lbs. \$2.00.
- Charcoal (Ground).** A little ground charcoal mixed with the soft feed in the morning, once or twice a week, keeps them healthy. 1 lb. 10c.; 5 lbs. 30c.; 10 lbs. 50c.; \$3.50 per 100 lbs.
- Cut Clover Hay (Niagara Brand).** Excellent food for winter and early spring. 50 lb. bag \$1.25; 100 lbs. \$2.00.
- Chick Manna, or Food for Little Chicks.** Specially prepared for little chicks when first hatched. Should be the first and only food, and continued for 10 or 12 days before feeding anything else. Directions for feeding on each package. 1 lb. pkge. 10c., by mail 25c.; 5 lb. pkge. 40c.; 60 lb. box, bulk \$4.20.
- Death to Lice Powder.** (Lambert's.) 15 oz. box 25c.; 48 oz. box 50c.; 100 oz. box \$1.00.
- Death to Lice Ointment.** (Lambert's) 1 oz. 10c.; 3 oz. 25c., postpaid.
- Eggs.** Thoroughbred poultry; for hatching; 30 varieties. Satisfaction guaranteed. Per 13 \$1.50; per 26 \$2.50.
- Incubator Eggs.** Per 100 \$6.00.
- Eggs (Nest).** Porcelain, per doz. 30c.; Medicated, per doz. 40c.
- Egg Testers.** 35c. each.
- Gape Cure.** (Madoc.) 6 oz. can 20c.; 7/8 lb. can 35c.
- "H. O." Poultry Food.** 5 lbs. 20c.; 75c. for 25 lbs.; per 100 lbs. \$1.65; \$27.00 per ton.
- Hemp Seed.** Used largely for feeding birds and pigeons. Per qt. 15c.; peck, 60c.; bush. \$2.00.
- Imperial Egg Food.** For making hens lay winter and summer; keeps the fowls in the best condition. 26 oz. package 25c., 50c. per 60 lb. package.
- Leg Bands (Aluminum).** 30c. per doz.; 25 for 50c.; 50 for 75c.; \$1.25 per 100.
- Meat for Poultry (Prepared).** This is prepared with great care. It is the finest thing we know of to cause hens to lay during the winter; extremely profitable to feed. 10 lbs. 40c.; 50 lbs. \$1.25; 100 lbs. \$2.50; 500 lbs. \$12.00; ton \$42.00.
- Mica Crystal.** For digestion. 5 lbs. for 15c.; 10 lbs. 25c.; 25 lbs. 40c.; 100 lbs. 85c. Two grades, fine and coarse.
- Oyster Shell (Fresh Ground).** The finest article to feed for shell making. 5 lbs. 10c.; 25 lb. bag 40c.; 100 lbs. 65c.; ton \$10.00.
- Peas (Canada Field).** Per qt. 10c.; peck 50c.; bush. \$1.10.
- Poultry Cure (Sturtevant's).** 25c. and 50c. per box.
- Pratt's Food for Poultry.** Will make hens lay all the year, and is excellent for feeding to young chicks. 1 1/2 lb. pkge. 25c.; 5 lb. pkge. 60c.; 12 lb. bag \$1.25; 25 lb. bag \$2.50.
- Pratt's Food for Horses and Cattle.** 5 lbs. 50c.; 12 lbs. 75c.
- Roup Preparation.** Sure cure. 1/2 lb. pkge. 20c.; 1 lb. pkge. 40c.
- Roup Pills (Havens).** Per box 25c.; per box of 250 pills \$1.00.
- Roup Pills (Sturtevant's).** 50 pills 25c.; 50c. per 250.
- Rust's Egg Producer.** 1 lb. 25c.; 2 1/2 lbs. 50c.; 6 lbs. \$1.00; 10 lbs. \$1.50; 25 lbs. \$3.50.
- Rust Haven's Condition Powder.** Small pkge. 25c.; 32 oz. 50c.; 5 lbs. \$1.00.
- Sheridan's Condition Powder.** 4 oz. pkge. 25c.; 2 1/4 lb. can \$1.00; six 2 1/4 lb. cans \$5.00.
- Sunflower Seed, Mammoth Russian.** Per qt. 10c.; peck 50c.; bush. \$1.50.
- Swinging Feed Trays for Poultry.** Saves all waste of food. Very practical. 18 inch \$1.00; 27 inch \$1.25; 36 inch \$1.50.

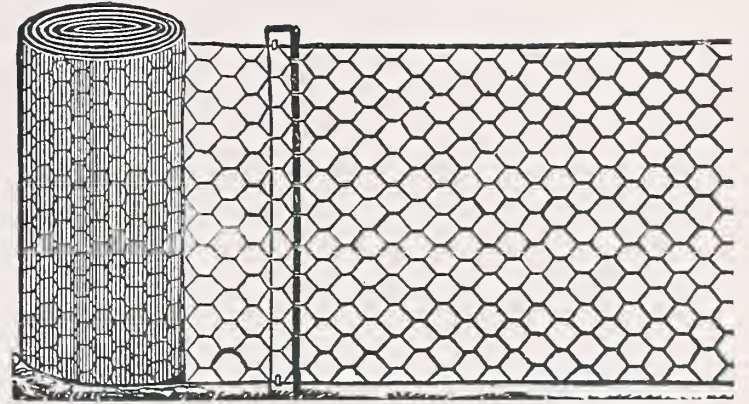

## Galvanized, No. 19, Wire Netting.

Galvanized after the netting is made, which makes it **Strong and Durable.** Special prices will be quoted on larger quantities.

The best thing for making poultry yards; better looking and cheaper than laths, and permits more light and air to enter. Prices may fluctuate.

12 in. wide, per bale 150 lineal ft. ....	\$0.98	42 in. wide, per bale 150 lineal ft. ....	\$3.15
18 " " " " 150 " " " " " " " " " "	1.47	48 " " " " 150 " " " " " " " " " "	3.60
24 " " " " 150 " " " " " " " " " "	1.95	60 " " " " 150 " " " " " " " " " "	4.50
30 " " " " 150 " " " " " " " " " "	2.45	72 " " " " 150 " " " " " " " " " "	5.40
36 " " " " 150 " " " " " " " " " "	2.90		

Any required length cut from above sizes at **1 1/4 cents** per square foot. Galvanized Staples for fastening, **10 cents** per pound.



## Mann's Standard Green Bone Cutters

The most economical machine for converting green bones, with the meat and gristle attached into poultry food.

- No. 1—C. Without wheel. Price . . . . \$6.00
- " 1—B. With wheel. Price . . . . . 7.50
- " 1—BM. With wheel (on stand) . . . . 10.00
- " 2—Best " " " " " " " " " . 18.40
- " 4—Without stand . . . . . 12.00
- " 4—With stand . . . . . 15.00

- Mann's Clover Cutter, with stand . . . . 10.00
- Mann's Clover Cutter, without stand . . . 8.00
- Mann's Swinging Feed Trays, 18 inch . . . 1.00
- Mann's Swinging Feed Trays, 27 inch . . . 1.25
- Mann's Swinging Feed Trays, 36 inch . . . 1.50

## Wilson's Best Oyster Shell and Dry Bone Mill.

Weights 39 lbs. Price \$4.50. With legs \$6.50.

This mill is adapted for grinding oyster shells, dry bones, corn meal, etc.; and, by means of a regulating wedge on the back, can be made to grind to any desired fineness.

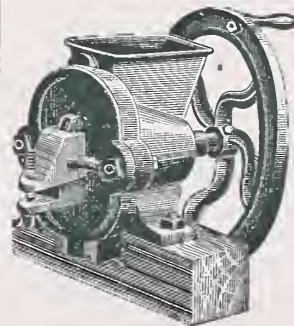

**Wigmore's No. 1 Caponizing Set.** German silver. In box \$2.25; in case \$2.50. Book on "Practical Caponizing and How to make Poultry Pay" free.



**French Poultry Killing Knife.** Made of fine steel. Price, with full instructions, 50c. each.

"Progressive" Killing Knife. Highly recommended. 5c.

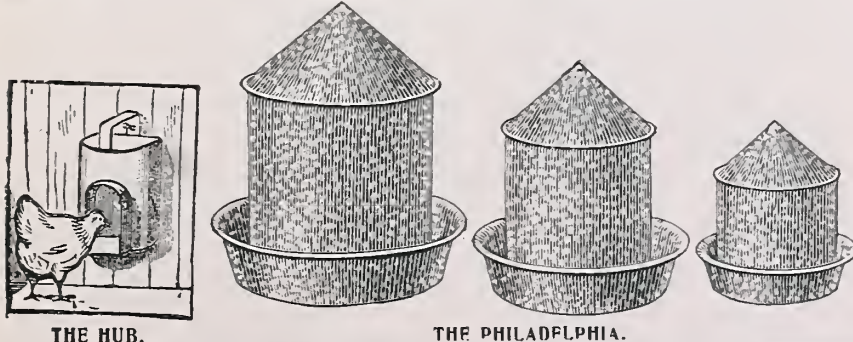

## POULTRY DRINKING FOUNTAINS.

All the most improved and reliable kinds; both in galvanized iron and stoneware. Prices, 2c. to \$1.00 each.

Pratt's Horse and Cattle Food. Pkge. 50c.; 12 lbs. 75c.; 25 lbs. \$1.50; 50 lbs. \$3.00.

THE BEST BOOK ON POULTRY. "PROFITS IN POULTRY."

A practical treatise on the business, giving designs for houses; artificial incubation, preparing for market, caponizing, etc. Price \$1.00.

# Watering Appliances, Hose, Etc.

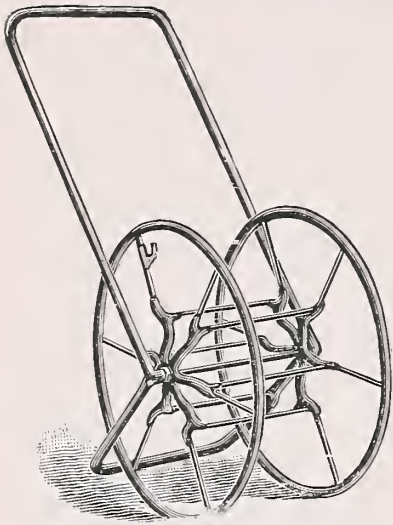

## Hose Reels.

Wirts' All Iron. Very Durable.

- No. 10. Holds 100 feet..... \$2.75
- No. 20. Holds 150 feet..... 3.25
- No. 30. Holds 300 feet..... 5.25

Also a number of other makes 75c. to \$2.50 each.

## Rubber Hose.

We Couple our Hose Free.

- Red Cross Brand. 3/4 in. 8c. per foot.
- Standard Brand. 3/4 in. 11c. per foot.
- Extra Standard Brand. 3/4 in., 3-ply, 12 1/2 c. per foot. With our guarantee.
- Extra Standard Brand. 3/4 in., 4-ply, 15c. per foot. With our guarantee.
- Chicago Electric (New). 16c. per foot.
- Wire Wrapped 3-Ply. 3/4 in. 12 1/2 c. per foot.
- "Cyclone." 1/2 inch. 11c. per foot.

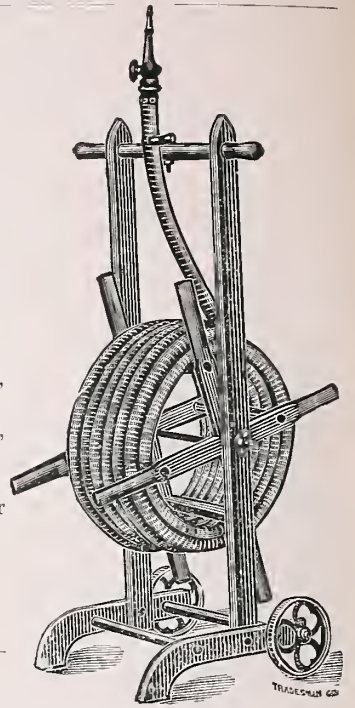

# LAWN SPRINKLERS, Etc., Etc.

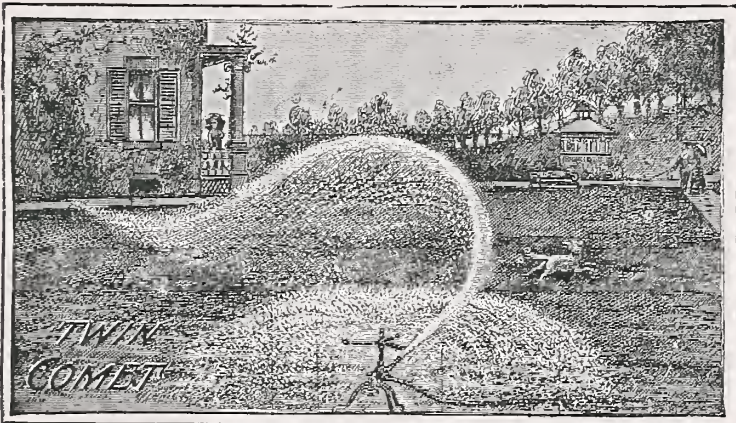

## The Twin Comet Lawn Sprinkler.

Will sprinkle an area four times greater than any other sprinkler made. Endorsed and adopted by Mr. Wm. Doogue, Superintendent of the Public Grounds of Boston, and in hundreds of other places. Price \$5.00.

**We have a very large assortment of all kinds of Lawn Sprinklers. 25c. to \$5.00 each.**

## Lyon's Fertilizing Lawn Feeder. (Odorless.)



It is a neat, light, little device, attached between the end of the hose and the nozzle, which automatically dissolves a stick of Lyon's Concentrated Lawn Food, diffusing it through as much water as will pass through an ordinary garden hose in 40 minutes. It is clean, odorless, non-poisonous, and will give perceptible results after one week's use on your lawn. It produces a dark green foliage and a healthy growth.

Complete outfit, consisting of one holder and twelve sticks of the food by mail, postpaid, 75c.

Additional Fertilizing Sticks, 50c. per box of 2 dozen.

## Leaf Rack.

Light and durable. Can be easily folded and detached, and the truck used with water barrel.

- 1 1/2 in. wheel..... \$10.25
- 2 1/2 in. wheel..... 11.50
- 4 in. wheel..... 13.00
- Leaf Rack only..... 4.50



## GALVANIZED WATER POTS

The best and most durable watering pot made. Each has two roses - one fine and one coarse.

4 quart, round,	\$1.50	Oval,	\$1.75
6 " " "	1.75	" " "	2.00
8 " " "	2.00	" " "	2.25
10 " " "	2.25	" " "	2.50
12 " " "	2.50	" " "	2.75
16 " " "	3.00	" " "	3.25

## Galvanized Iron Clad WATERING CANS.

The best cheap watering can in the market. Very durable. Sizes 4 to 20 quarts, 50c. to \$1.50 each.

Wotherspoon's Make.

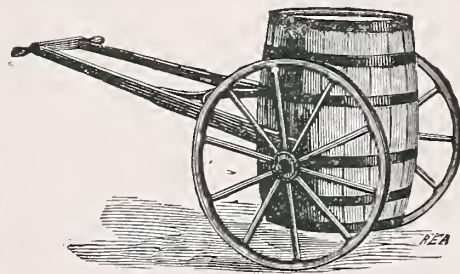

## Water Truck and Barrel.

Barrel can be detached from truck without difficulty, or tilted to empty contents. Other barrels can be used and extra irons furnished if desired. The weight is balanced over the axle.

- 1 1/2 inch wheels..... \$ 9.00
- 2 1/2 inch wheels..... 10.00
- 3 1/2 inch wheels..... 11.00
- Large box to fit on truck, extra ..... 2.75
- Leaf rack attachment to the water truck ..... 4.50
- Sprinkling attachment ..... 3.50
- Extra barrels with trunions..... 2.50

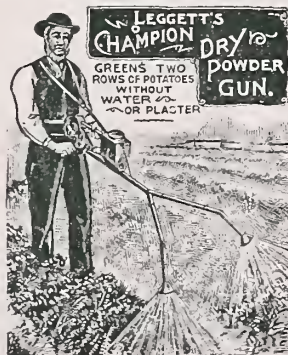

## Leggett's Paris Green Distributor.

The very best and most economical device. Price \$7 00.

## "Lightning" Double Tube Insect Exterminator.

All Copper. Cannot Rust. Price \$1.00 each.

These machines have been used by the leading florists and gardeners in the United States, with the greatest degree of satisfaction. It throws a spray as fine as a cloud of smoke, which being damp, adheres to the plant; it is worth its cost many times each season. Kerosene Emulsion may be used on most any kind of plant without harming same.

When using operate with a quick stroke.

# LAWN MOWERS, Etc.

THE "GREAT AMERICAN" BALL BEARING LAWN MOWER.

HIGH WHEEL

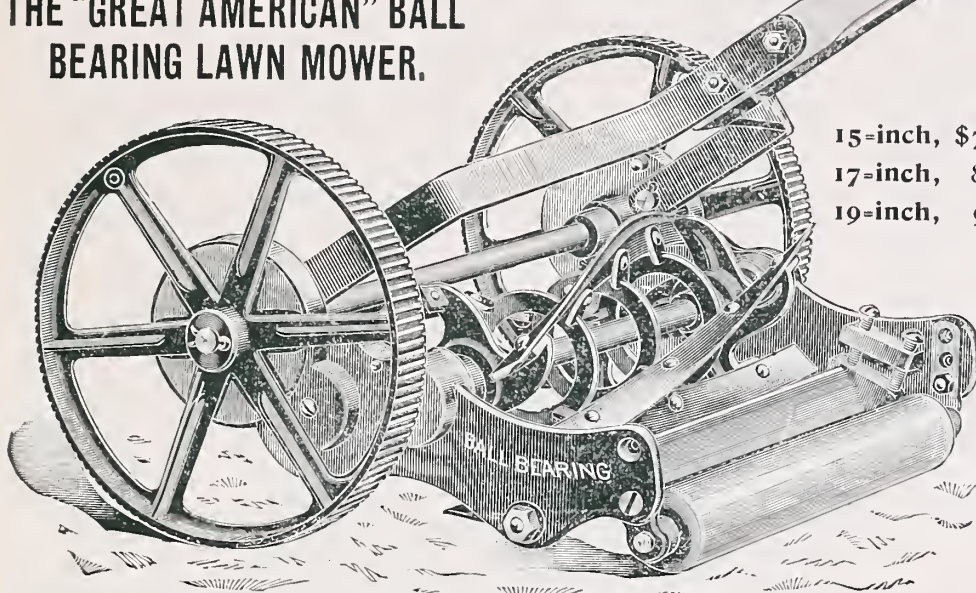

15-inch, \$7.50  
17-inch, 8.25  
19-inch, 9.00

## PENNSYLVANIA AND CONTINENTAL LAWN MOWERS.

10-inch.....\$5.25	16-inch.....\$7.50
12-inch.....6.00	18-inch.....8.25
14-inch.....6.75	
15-inch High Wheel...\$10.00	19-inch High Wheel.....\$12.00
17-inch High Wheel... 11.00	21-inch High Wheel..... 13.00
25-inch PONY Mower.....\$30.00	

## WARFIELD'S NEW LAWN SWEEPER.

Sweeps 24 inches wide. Very satisfactory. Saves labor and time.

Price ..... \$10.00

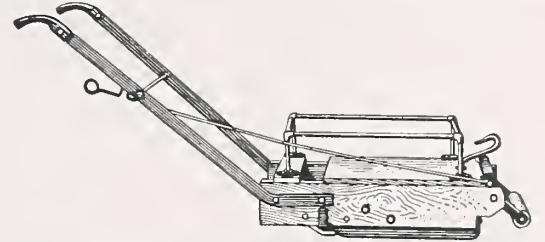

## NEW CHAMPION SOD CUTTER.

The best and most satisfactory machine on the market.

Price \$22.00.

## BRAUN'S GRASS CATCHER SUITABLE FOR PENNSYLVANIA AND CONTINENTAL LAWN MOWERS.

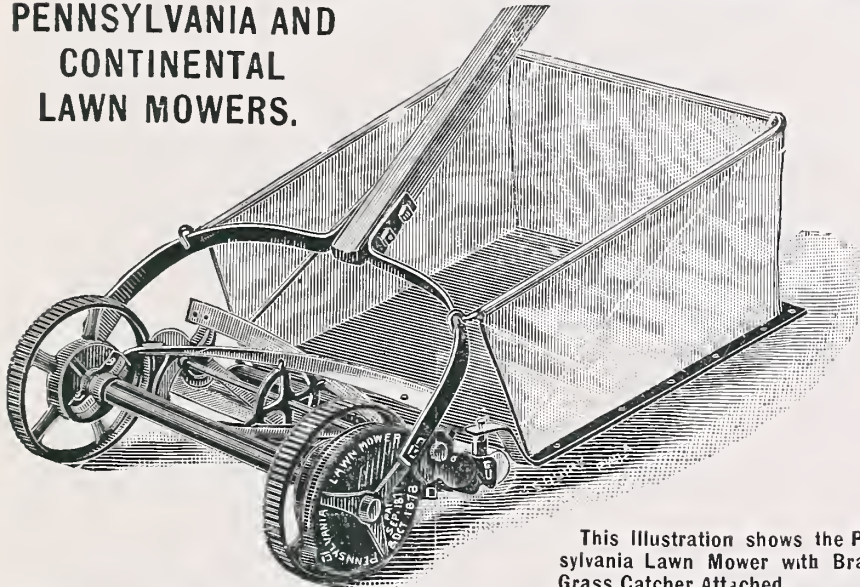

This illustration shows the Pennsylvania Lawn Mower with Braun's Grass Catcher Attached.

## Braun's Grass Catchers TO FIT PENNSYLVANIA, CONTINENTAL, GREAT AMERICAN, GIRARD AND NEW DEPARTURE LAWN MOWERS.

10 in. \$1.25	12 in. \$1.35	14 in. \$1.45	16 in. \$1.55	18 in. \$1.65	15 in. \$1.55	17 in. \$1.65	19 in. \$1.75	21 in. \$1.80	25 in. \$2.25
---------------	---------------	---------------	---------------	---------------	---------------	---------------	---------------	---------------	---------------

Triumph Grass Catcher. } Adjustable, practicable and cheap. { 10, 12, and 14 inch, 60c. each. 16, 18, and 20 inch, 85c. each.

"Pennsylvania" Horse Lawn Mower.

Open cylinder with draft irons, 30 in. cut, \$65.00.  
Seat, Shafts and Springboard for these mowers, \$13.00 extra.  
Close Cylinder, 30 inch, with draft irons, \$65.00.  
38 inch, with draft irons, \$85.00.  
With seat and shafts \$13.00 extra.

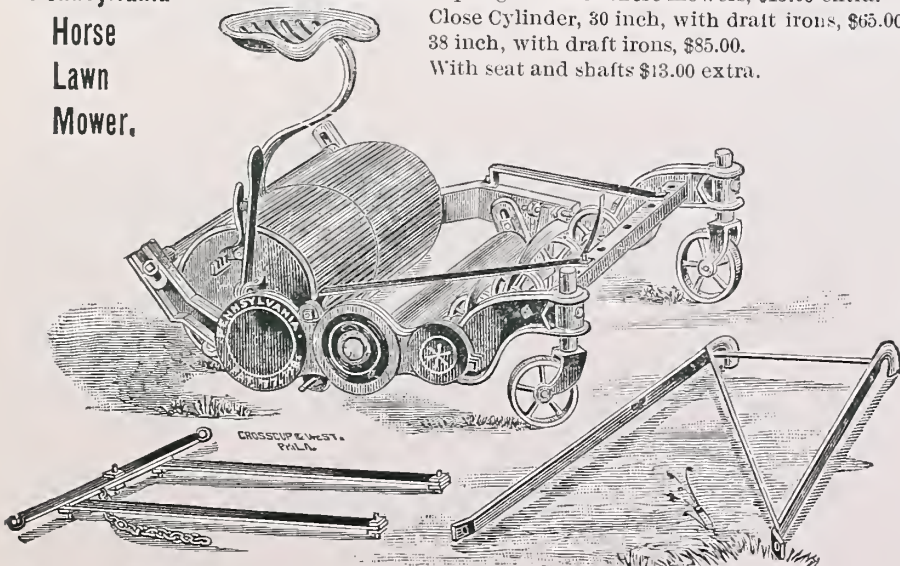

## PHILADELPHIA HORSE LAWN MOWERS

30 inch, with draft irons.....\$66.00	With seat and shafts.....\$79.00
35 inch, with draft irons..... 79.00	With seat and shafts..... 92.50

## PHILADELPHIA LAWN MOWERS (Style S.)

10-inch cut.....\$4.75	14-inch cut.....\$6.25	18-inch cut.....\$7.75
12-inch cut..... 5.50	16-inch cut..... 7.00	

## THE "NEW DEPARTURE" LAWN MOWER.

No Sharpening.		No Setting.	
10-in. cut....\$3.25	12-in. cut...\$3.50	14-in. cut...\$3.75	16-in. cut...\$4.25

## GIRARD LOW WHEEL.

10-inch.....\$2.50	12-inch.....\$2.75	14-inch.....\$3.00
--------------------	--------------------	--------------------

## GIRARD NEW HIGH WHEEL.

14 inch.....\$3.50	16 inch.....\$3.75	18-inch.....\$4.00
--------------------	--------------------	--------------------

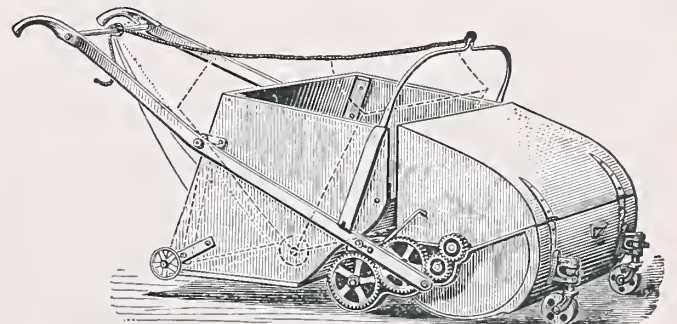

## PHILADELPHIA LAWN SWEEPER.

A simple machine for cleaning the lawn. A driving roller gives motion to a revolving brush placed directly in front, causing it to sweep the sod clean and throw the sweepings backward from the top of the brush into a large box in the rear of the roller. The box can be dumped without stopping. Sweeps 40 inches wide, \$55.00.



## Lawn Boots for Horses.

Made of best quality leather. All hand riveted. With extra toe piece. Price per set of four.....\$7.50

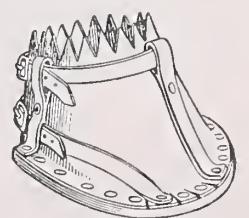

## Champion Lawn Boots.

Extra strong. \$8.00 per set of four.

# Coldwell's Improved Horse Mowers.

EVERY MOWER IS GUARANTEED TO GIVE SATISFACTION OR NO SALE.

These mowers are used on the Public Parks of Paris, France, New York City, Brooklyn, Baltimore, Chicago and Buffalo, etc., and have also been furnished to the U. S. Government for the past seven years.

## Coldwell's New High Wheel Light Running, Ball Bearing Lawn Mowers.

14-inch . . . . .	\$ 8.00
16-inch . . . . .	9.00
18-inch . . . . .	10.00
20-inch . . . . .	11.00

We Prepay Freight Charges on all Coldwell's Horse Mowers shipped direct from the factory.

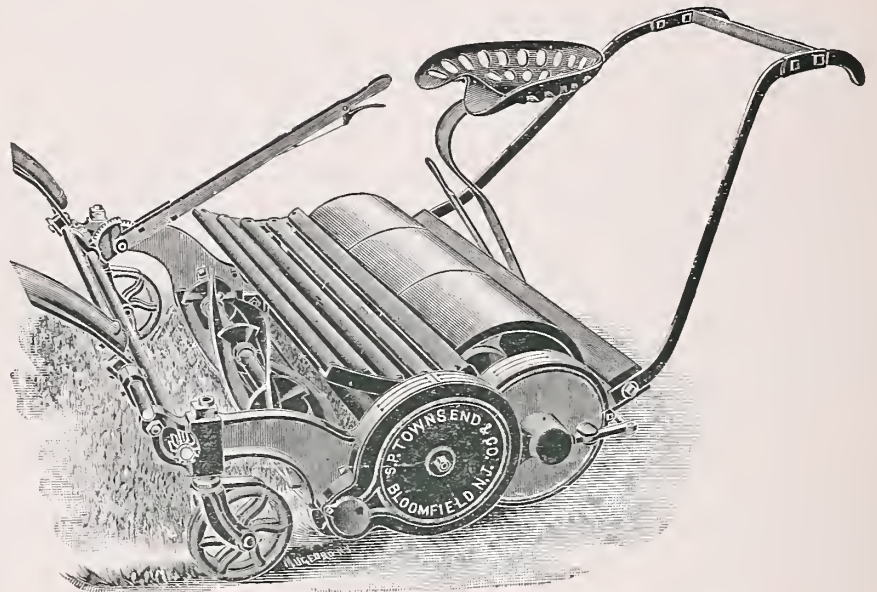

COLDWELL'S IMPROVED HORSE LAWN MOWER.

25-in., no shafts . . . . .	\$37.50	35-in., with seat and shafts	75.00
30-in., with draft irons . . . . .	54.00	40-in., with draft irons . . . . .	84.00
30-in., with seat and shafts	60.00	40-in., with seat and shafts	90.00
35-in., with draft irons . . . . .	69.00		

December 7th, 1899.  
Dear Sir:—At the end of the mowing season, I think in justice, I should let you know of the satisfaction I have had with the COLDWELL Horse Mower I bought of you in the spring. I refer to the good material in all the blades, which have stood the season's work without showing any dents or breaks, and to the perfection of its work. For the sake of the horse, also, I am glad that I bought a Coldwell Horse Mower with seat and shafts. The horse cannot back on to the blades of the machine, or get tangled up in the braces, which often used to occur while using mowers without seat and shafts.  
Very respectfully,  
EDWARD JONES,  
Head Gardener to Mrs. J. W. M. Cardeza,  
Washington Lane, Germantown.

Kinzer's, Lancaster Co., Pa., May 7th, 1899.  
Mr. Henry F. Michell,  
Dear Sir:—The COLDWELL Lawn Mower which we purchased of you works like a charm. We are more than pleased with it.  
JOHN C. RODGERS,  
Gardener to Hon. W. U. Hensel.

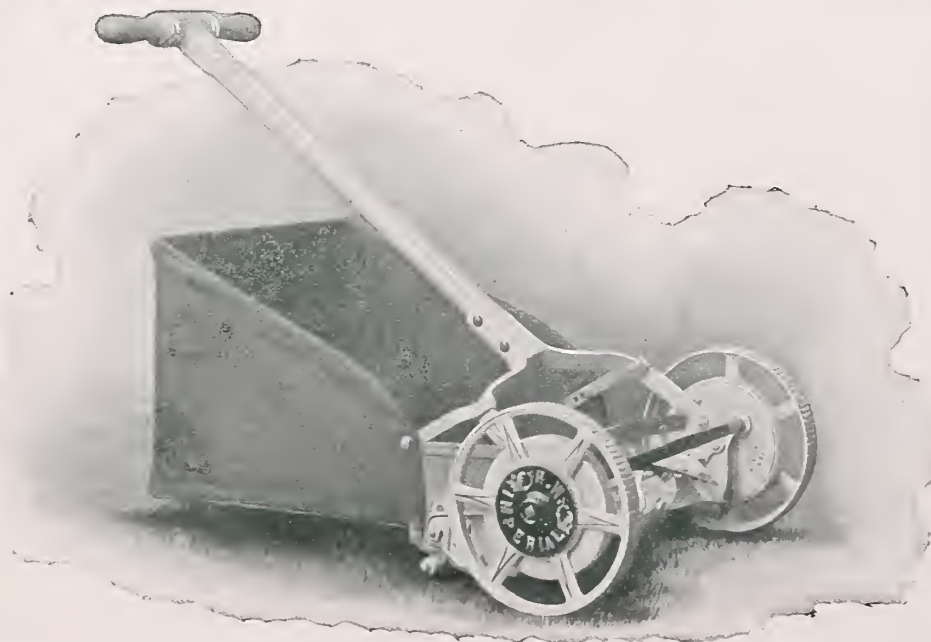

## The Famous Imperial Hand Lawn Mowers.

(GUARANTEED.)

	High Wheel,		Low Wheel.
	4 Blade.	5 Blade.	
14-inch . . . . .	\$7.00	\$8.00	\$6.50
16-inch . . . . .	8.00	9.00	7.50
18-inch . . . . .	9.00	10.00	8.50
20-inch . . . . .	10.00	11.00	

Grass Catchers.
\$1.50
1.65
1.80
1.95

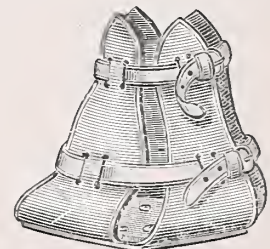

## Horse Boots for Lawn.

Extra well made; will wear out two sets of cheap boots.

\$7.50 per set of four.

## New Golf Greens Mower.

ROLLER MOWER.

Used on the leading Golf Links in this country; offered with either four or six blades in the Revolving Cutter. It has no equal where fine work is required. Considered the finest cutting and lightest running Roller Mower made in the world. It shaves the grass.

14-inch, including Grass Catcher . . . . .	\$13.00
16 " " " " . . . . .	14.50
18 " " " " . . . . .	16.00

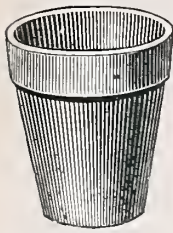

**Standard Flower Pots.**

Full inside measurement, height and width.

No charge for barrels or packing.  
6 supplied at dozen rates. 50 supplied at 100 Rates.  
500 supplied at 1000 Rates.

Please note the reduction in prices.  
Compare with others.



Size, inches height and width inside.	Per doz.	Per 100	Per 1000
1 3/4.....	\$0.06	\$0.44	\$3.46
2.....	.07	.50	3.96
2 1/4.....	.08	.56	4.45
2 1/2.....	.09	.69	5.45
3.....	.11	.88	6.93
3 1/2.....	.14	1.06	8.41
4.....	.18	1.38	10.89
4 1/4.....	.20	1.56	12.37
4 1/2.....	.24	1.88	14.85
5.....	.32	2.50	19.80

Size, inches height and width inside.	Per doz.	Per 100	Per 1000
5 1/2.....	\$0.41	\$3.13	\$24.75
6.....	.49	3.75	29.70
6 1/2.....	.62	4.80	44.00
7.....	.78	6.00	55.00
8.....	1.09	8.40	77.00
9.....	1.56	12.00	110.00
10.....	2.11	16.20	148.50
11.....	2.81	21.60	
12.....	3.90	30.00	
14.....	7.80	60.00	

We can also supply the old fashioned Hand Made Pots.  
Price List sent on application.

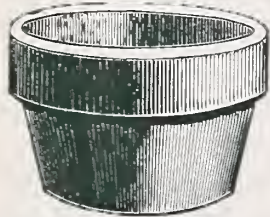

**Bulb Pans.**

(Earthenware)



**Pot Stands or Saucers.**

Width.	Height.	Per doz.	Per 100.
6 in.	3 in.	\$0.68	\$3.75
7 "	3 1/2 in.	.78	4.80
8 "	4 "	.98	6.00
9 "	4 1/2 "	1.30	8.40
10 "	5 "	1.63	10.80
12 "	6 "	2.28	15.00
14 "	7 "	4.55	30.00
16 "	8 "	7.80	60.00
18 "	9 "	11.70	90.00

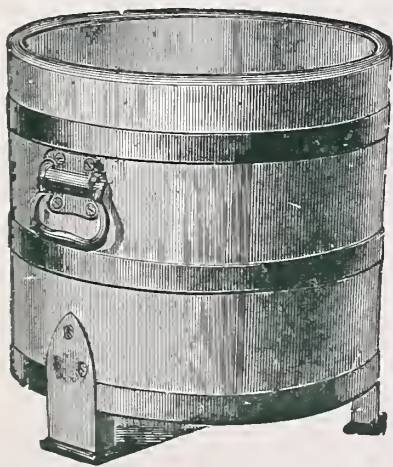

**Improved White Cedar Plant Tubs.**

Made of white cedar, bound with extra heavy iron hoops Drop handles of special pattern, serving as hooks. Substantial iron feet of original design. Removable perforated bottoms, painted green outside and brown inside.

No.	Outside diam.	Length of stave.	Price
0	27 in.	24 in.	\$5.00
1	25 "	22 "	4.50
2	23 "	20 "	3.75
3	21 "	18 "	3.25
4	19 1/2 in.	16 "	2.75
5	18 "	14 "	2.40
6	16 1/2 "	13 "	2.00
7	15 "	12 "	1.75
8	14 "	10 "	1.50

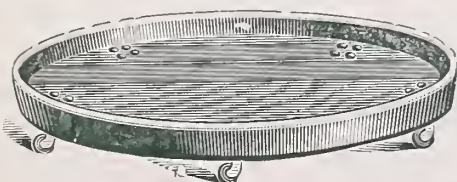

**Rolling Stands.**

For Heavy Plants and Palms.  
Made of Indurated Fibre Ware.

Will not soak or rust. Casters have ball bearings Every heavy plant sold needs one to save carpets and floors.

Size.	Will fit pot or tub.	Each.	Doz.	Size.	Will fit pot or tub.	Each.	Doz.
12 inch.	10 inch.	\$0.65	\$7.20	18 inch.	16 inch.	\$1.10	\$12.00
13 "	11 "	.75	7.80	20 "	18 "	1.35	15.00
14 "	12 "	.85	9.00	22 "	20 "	1.60	18.00
16 "	14 "	.95	10.00				

**Galvanized, Painted Green Tub Saucers.**

50c. to \$1.50 each.

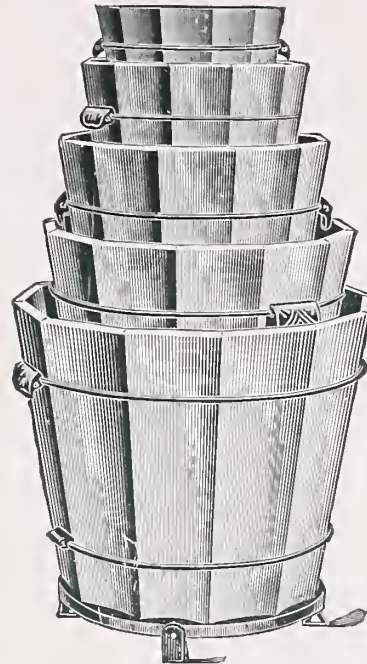

**Columbia Plant Tubs.**

We have had numerous demands for low priced tubs, and find these suitable, ornamental and durable.

12 in. diam. x 11 in. high, each.....	\$1.00
15 " " x 14 " " " ".....	1.50
18 " " x 16 " " " ".....	2.00
21 " " x 18 " " " ".....	2.50
24 " " x 20 " " " ".....	3.00

**"UNION" Plant Tubs.**

Made of Cypress, painted green, iron feet.

No.	Diam.	Length of Staves.	Price.
1	13 in.	11 in.	\$0.75
2	14 1/2 in.	13 "	1.25
3	16 "	15 "	1.75
4	20 "	18 "	2.25
5	24 "	21 "	2.75

**Flower Pot Saucers.**

Made of Wood Fibre.



Unbreakable. Are not porous, and will protect woodwork, tables, etc., on which plants are to stand.

	Per doz.	Per 100.
4 inch.	\$0.75	\$6.00.....100 in crate
5 "	.80	6.25.....100 "
6 "	.85	6.75.....100 "
7 "	.90	7.10.....100 "
8 "	.95	7.60.....100 "
9 "	1.00	8.20..... 50 "
10 "	1.05	8.70..... 50 "
11 "	1.20	9.10..... 50 "
12 "	1.35	10.00..... 25 "
13 "	1.50	12.00..... 25 "
14 "	2.00	15.00..... 25 "

**PLANT STAKES.**

**PAINTED STAKES.**

	Doz.	100		Doz.	100
1 1/2 ft. painted green.....	\$0.15	\$0.90	3 ft. heavy or dahlia.....	\$0.67	\$4.30
2 "	.25	1.55	3 1/4 "	.78	5.00
2 1/2 "	.38	2.35	4 "	.88	5.70
3 "	.46	2.95	5 "	1.10	7.10
3 1/2 "	.58	3.70	6 "	1.30	8.50
4 "	.67	4.30			

**BAMBOO OR CANE STAKES.**

Always on Hand.

8 to 12 feet long (250 for \$2.00).....	Per 100 \$1.00	Per 1000 \$6.50
---	----------------	-----------------

**UNPAINTED STAKES OR DOWELS.**

	Per 100	Per 1000
36 inches long, 1/4 inch diameter.....	\$0.55	\$4.75
42 " " 3/4 " " ".....	.65	5.00
42 " " 5/8 " " ".....	.75	6.00
42 " " 1/2 " " ".....	1.00	7.50

**GALVANIZED STEEL PLANT STAKES.**

Used by leading gardeners and florists for Roses, Carnations, etc. They are neat and durable.

	Per 100	Per 1000		Per 100	Per 1000
2 feet long.....	\$0.70	\$5.75	4 feet long.....	\$1.50	\$11.75
2 1/2 " ".....	.85	6.75	4 1/2 " ".....	1.65	13.00
3 " ".....	1.00	8.00	5 " ".....	1.75	14.00
3 1/2 " ".....	1.25	10.00			

**GALVANIZED WIRE IN ROLLS.**

No. 16 and No. 18, 10 cts. per lb.; \$1.00 per roll of 12 lbs.  
No. 20, 12 cts. per lb.; \$1.20 per roll of 12 lbs.

**POT LABELS--Painted.**

	Per 100	Per 1000		Per 100	Per 1000
3 1/2 inch.....	\$0.10	\$0.75	6 inch.....	\$0.25	\$1.25
4 "	.12	.85	8 inch.....	.35	2.50
4 1/2 "	.15	1.00	10 inch.....	.50	4.00
5 "	.20	1.10	12 inch.....	.75	5.25

**PAINTED TREE LABELS.**

3 1/2 inch, notched or pierced. Per 100 15c., per 1000 \$1.00.  
**Copper Wired**, \$1.25 per 1000.

**INDESTRUCTIBLE COPPER LABELS.**

Made of prepared copper, thin and pliable; can be written on with a pencil, which indents the copper, leaving a permanent impression. A little white lead, rubbed with the finger on the face of the label, before the name is written, will make it more conspicuous. Per doz. 20c., per 100 \$1.00.

# INSECT DESTROYERS, ETC., ETC

**Aphis Punk.** (*Nikoteen*.) Especially designed for use in private places and in houses without convenient furnaces for heating irons necessary for vaporizing. **Nikoteen** or Tobacco Extract. It is very effective as an insecticide and so easy of application that its advantages in this respect are instantly apparent to the user. The Punk is lighted with a match and allowed to burn, which it does without flaming at the same time giving off dense white fumes of nicotine that kill aphids and thrip very effectively. The fumes from Aphis Punk contain no Ammonia, the element in tobacco smoke that damages sensitive plants, so that it can be used anywhere without danger of injuring the most delicate blooms. 60c. per box. Per 12 boxes \$6.50.

**Ant Exterminator.** Very effectual for destroying ants in gardens and lawns. Per pkge. 25c., 50c., \$1.00.

**Bordeaux Mixture.** For black rot, downy mildew, and anthracnose of grape, potato blight, potato rot, leaf blight of cherry, pear, quince and other fungus diseases. 5 lbs. 60c., makes 25 gallons spray; 10 lbs. \$1.00, makes 50 gallons spray; 25 lb. box makes 125 gallons spray, \$2.50.

**Bordeaux Mixture.** In liquid form, 40c. per qt.; \$1.00 per gallon.  
**Catterpillar Lime, Ermish's.** Cans of 5 lbs. \$1.00, 10 lbs. \$1.75, kegs of 25 lbs. \$3.75, 50 lbs. \$6.75.

**Copperdine.** For black rot, carnation rust and anthracnose of the grape, pear leaf blight, apple scab and powdery mildew. One gallon can (makes 100 gallons wash), per qt. 50c., per gal. \$1.50, five gal. can, \$6.25.

**Copper Soap.** (*Permol.*) Positive cure for mildew, rust and all fungus. 75c. per can.

**Dalton or Persian Powder.** Pure 1/4 lb. 15c., lb. 40c.  
**Fir Tree Oil.** For destroying insects, such as mealy bug, red spider, scale, thrip, green fly, etc. Full directions with each can. Qt. \$1.50, pt. 75c., 1/2 pt. 50c., small bottle 25c., \$2.75 per 1/2 gallon, per gallon \$5.00.

**Fir Tree Oil Soap.** Per can 25c. and 50c. each.  
**Fostite.** Prevents mildew. Five lbs. 50c., 25 lbs. \$2.00.

**Gishurst's Compound.** Extensively used for preventing and destroying green fly, mildew, thrip, mealy bug and scale. Box 50c., 3 lb. box \$1.00.

**Good's Caustic Potash Whale Oil Soap.** Per 50 lb. keg \$3.00, per lb. 10c.  
**Grape Dust.** Best remedy for mildew. 5 lb. pkge. 30c. 100 lb. keg, \$5.00.

**Hellebore.** For destroying rose slugs. With directions. Lb. 25c., 1/2 lb. 15c.

**Kerosene Emulsion.** For plant lice of any kind, cabbage worms, scale, insects on apple, pear, orange, lemon and other trees. 5 lb. can 60c., makes 50 gallons of spray. 25 lb. can \$2.50, makes 250 gallons of spray.

**Kraft's Palm Wash.** 75c. per qt., \$1.40 per 1/2 gal., \$2.65 per gal.  
**Kraft's Tonic and Insecticide.** 25c. per bottle, 75c. per qt., \$2.65 per gal.

**Lemon Oil.** Will destroy mealy bug, scale, thrip, red spider, etc. 25c. per 1/2 pt., per pt. 40c., 75c. per qt., per 1/2 gal. \$1.25, \$2.00 per gal, per 5 gal. keg, \$9.00.

**London Purple.** Cheaper and less dangerous than Paris green. Lb. 20c., 5 lbs. 90c. Special price on larger quantity.

**Nikoteen.** One of the most economical and powerful nicotine extracts. One part to 600 of water is sufficiently strong to kill all insects except scale, for which use one part to 400 parts of water. Per pint \$1.50. Outfit for using Nikoteen \$3.00, complete.

**Paris Green Pure.** Lb. 25c., 5 lbs. \$1.20, 14 lb. buckets \$3.00.

**Persian Insect Powder.** Fresh and pure. 15c. per 1/4 lb., per lb. 40c.  
**"Pillar Catter."** The most effectual device yet introduced to prevent caterpillars from infesting trees. Per yd. 15c.

**Quassine.** Per gal, \$1.25.  
**Rose Leaf Extract of Tobacco.** Per qt. 50c., per gal. \$1.25, 5 gal. \$4.25.

**Seal Oil Soap.** 1 lb. can, 25c., 10 lbs. for \$2.00.  
**Slug Shot.** 5 lbs., 25c., 10 lbs. 50c., 100 lbs. \$4.25. Bulk, in barrels weighing about 225 lbs., 3 3/4c. per lb.

**Sulphur.** A preventive and cure for mildew. Lb. 7c., 5 lbs. 30c., 100 lbs. \$4.00.

**Thrip Juice.** 50c. per qt., per gal. \$1.75.  
**Tobacco Dust.** Cheaper than snuff and quite as effectual. Sure remedy for green fly. 5 lb. pkge. 25c., 100 lb. \$3.00.

**Tobacco and Whale Oil Soap.** Sure destroyer of green and black fly, mealy bug and other insect pests. 25c. per pkge., \$2.75 per doz. pkges.

**Tobacco Soap.** (*Pinuer's*.) For destroying insects, parasites and their eggs, infesting either plants or animals. Lb. 40c.

**Tobacco Stems Fresh.** For fumigating. Lb. 10c., bbl., \$1.00, hales of about 250 lbs. \$2.00, per 1/2 ton \$6.00, per ton, \$11.00.

**Whale Oil Soap.** For destroying and preventing insects on plants, trees, vines, etc., for washing down the bark of trees, grape vines, etc. In cans, with directions, 20c., 35c. and 50c.; in hulk, 10 lbs. 90c.

## READE'S ELECTRIC WORM ERADICATOR

The best article yet discovered for destroying worms. 50c., \$1.00 and \$3.00 per bottle

Rockwood Hall, Tarrytown, N. Y.

Gentlemen:—Your "Electric Worm Eradicator" works like a charm in the greenhouses, we were astonished to see the worms and hogs that came to the surface when we applied it, and it does not hurt trees, flowers or grass.

Yours very truly, B. M. HAWKS, Supt. to Wm. Rockefeller, Esq.

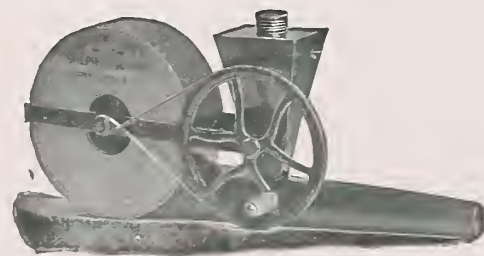

**"Peerless" Sulphur and Insecticide Blower.**

This is the most satisfactory distributor of Sulphur and other Insecticides in powder form. Will never wear out. Satisfaction guaranteed. Price \$4.75.

### THE STANDARD PARIS GREEN DUSTER.

\$5.00 each; large size double gun, \$7.00 each

## KNAPSACK SPRAYER Deming's Best.

Copper, \$11.00.

## BELLOWS FOR APPLYING THE INSECT DESTROYERS.

Large Double Cone . . . . .	Each \$3.00	Liquid Spraying . . . . .	Each \$1.50 and \$2.00
Large Single Cone . . . . .	Each 2.00	Sulphur Bellows . . . . .	Each \$1.50
Small Single Cone . . . . .	Each 1.00		

## ...SYRINGES...

DEAKIN'S BRASS GARDEN SYRINGES.

Length of Barrel, 13 1/2 in.; diam., 1 1/8

No. A.	1 stream and spray hose, 12 x 1 inches	.....	\$2.00
No. B.	1 " " " " 13 x 1 1/4 "	.....	2.75
No. C.	1 " " " " 14 x 1 1/2 "	.....	3.25
No. 2.	1 " " 2 roses, 13 1/2 x 1 3/8 "	.....	4.00
No. 5.	1 " " 2 " 18 x 1 1/2 "	.....	6.00
No. H.	18 inches long, 1 1/2 inches in diameter	.....	2.15
	With Movable Spray . . . . .	.....	2.30



**A. & W. Hose Band.**

No special tools required. Engage the lever in the farthest notch it can reach, press down lever, then hammer down ears and the lever is locked. The lever cannot slip. Each 5c.; per doz. 45c.

**NEW STANDARD HOSE MENDER.**

10c. each; \$1.00 per doz.

**HUDSON'S HOSE MENDERS.**

Complete outfit of Six Menders with Pliers, 65c.; by mail, 75c.

**Separate Menders.** 42c. per doz.

**Separate Bands.** 24c. per doz.

**HOSE MENDERS. (Woodson's, Iron).**

1/2 inch 5c. each, doz. 45c.; 3/4 inch, each 5c., doz. 50c.; 1 inch, each 8c., doz. 75c.

**COOPER'S HOSE MENDERS.**

**ALL BRASS.** 10c. each, \$1.00 per doz.



**THE "PERFECT SUCCESS" COMBINATION SPRAY PUMP.**



**For Spraying Trees, Plants, &c., &c.**

There is no better and more complete outfit for so little money. The "Perfect Success" Pump includes "Bordeaux" Nozzle and a special greenhouse nozzle. Price \$5.00. 7 foot hose extension and pole connection \$1.25 extra.

**Success Spray Pump.**

Similar to the "Perfect Success," but without Extension Hose and Fixtures. \$4.00.

### GEM HOSE NOZZLES. For throwing fine or coarse spray, or straight stream. Each 35c;

<b>Boston Spray Nozzle.</b>		<b>VERMOREL NOZZLE.</b>	
Made of copper.		75c. each.	
Fine or coarse spray.			
50c. each.			

**The Improved "Bordeaux" Spray Nozzle.**

Price 3/4 inch pipe and 1/2 inch hose, as per cut, 75c.

**BORDEAUX**



**Water Tight Hose Coupler.**

Instantaneous in operation. Simplicity itself. Can be operated by a child. No screws to get out of order. Nothing to get damaged or broken. Per pair 25c.; per doz. pairs \$2.50.

**DISCONNECTED.**



**ACME HOSE CROOK and SWIVEL JOINT.**

Saves the hose and doubles its life. Attached to ground pipe or spigot. Bending of the hose is avoided. Hose does not wear out from the friction of the water, but from the constant bending and twisting to which it is subjected. The use of the crook removes the greatest cause of wear. Each 50c.; per doz. \$5.00.

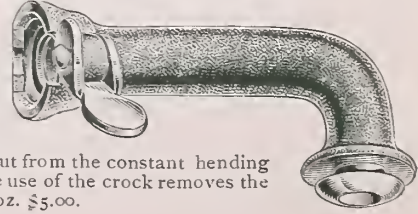



# STRICTLY PURE FERTILIZERS

Of the Very Best Quality.

A FEW LEADING BRANDS:

**BONE MEAL.** *Michell's Strictly Pure and Fresh.* In fertilization nothing takes precedence in importance over animal bones, because they furnish the soil with the essential requisite of nitrogen as well as phosphoric acid. The most substantial fertilizer for lawns and plants. It keeps on feeding the soil for fully ten months. 3-lb. box, 15 cts.; 5-lb. bag, 25 cts.; 10 lbs., 40 cts.; 25 lbs., 75 cts.; 100 lbs., \$2.00; sack of 200 lbs., \$3.50; ton, \$30.00.

**SHEEP MANURE.** *Pure, Fresh, Pulverized.* One of the richest general fertilizers. *Elliott's XX Brand*, 2 lbs., 15 cts.; 4 lbs., 25 cts.; 10 lbs., 50 cts.; 25 lbs., \$1.00; 50 lbs., \$1.50; \$2.25 per 100 lbs.; \$32.00 per ton.

**POUDRETTE.** This is now considered among the very best fertilizers in the market. It is very reasonable in price and high in fertilizing qualities, and of a lasting character. \$1.50 per 100 lbs.; \$10.00 per 1/2 ton; \$15.00 per ton. Special price in quantity.

**BONE FLOUR.** *Pure.* Ground perfectly fine; excellent for pot plants or beds where an immediate effect is wanted. 5 lbs., 25 cts.; 25 lbs., \$1.25; 100 lbs., \$2.50; bag or bbl. of 200 lbs., \$4.50; ton, \$40.00.

**CLAY'S FERTILIZER.** Imported manure especially recommended for flowers or vegetables, to bring the highest perfection. Should be used in potting soil, and spread on staging of greenhouses planted with flowering plants. 25-lb. bag, \$2.00; 50 lbs., \$3.50; 100 lbs., \$6.50.

**HORN SHAVINGS.** A very valuable and rich fertilizer, especially for roses, chrysanthemums, etc. 10 cts. per lb.; 25 lbs., \$1.75; \$5 00 per 100 lbs.

**"JADOO" FIBRE.** *The Great, New, Popular and Practical Fertilizer.* 4-lb. tin box, 25 cts.; 10 lbs., 50 cts.; 25 lbs., \$1.10; 2 cts. per lb. in original sacks, containing 125 lbs.; 500 lbs. and upwards at 1 1/4 cts. per lb. Full directions accompany each package.

**"JADOO" LIQUID.** Is the cheapest fertilizer sold. Both meat and drink to plants. 25 cts. per pint bottle; \$1.50 per 2 gallon jug.

**NITRATE OF SODA.** For all crops. Contains the largest percentage of nitrogen; equal to 19 per cent. of ammonia. 5 lbs., 30 cts.; 10 lbs., 50 cts.; 25 lbs., \$1.10; \$3.75 per 100 lbs.

## Thomson's Imported Plant Manure.

This is one of the very best Fertilizers, introduced from England, and can be highly recommended to any one wishing an immediate effect in forcing. Highest testimonials from those who have tested its merits. Put up in original bags. 28 lbs. (1/4 cwt.), \$1.75; 56 lbs. (1/2 cwt.), \$3.25.

We can also supply all other Fertilizers at lowest market rates.

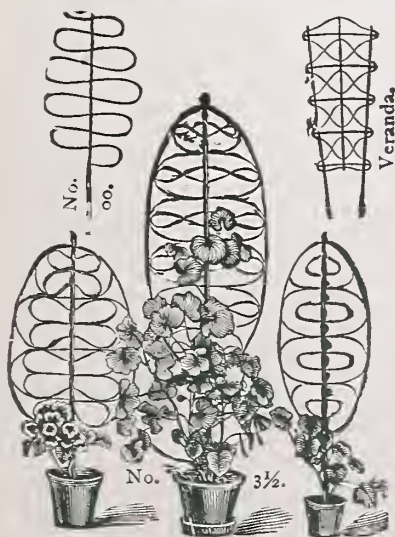

## TRELLISES.

For Training Vines. Each 10 cts. to \$1.00.



## WRIGHT'S LAWN WEEDEE

The best Weed extractor. Each \$1.00  
CLEVELAND WEED EXTRACTOR  
50 cts. each.

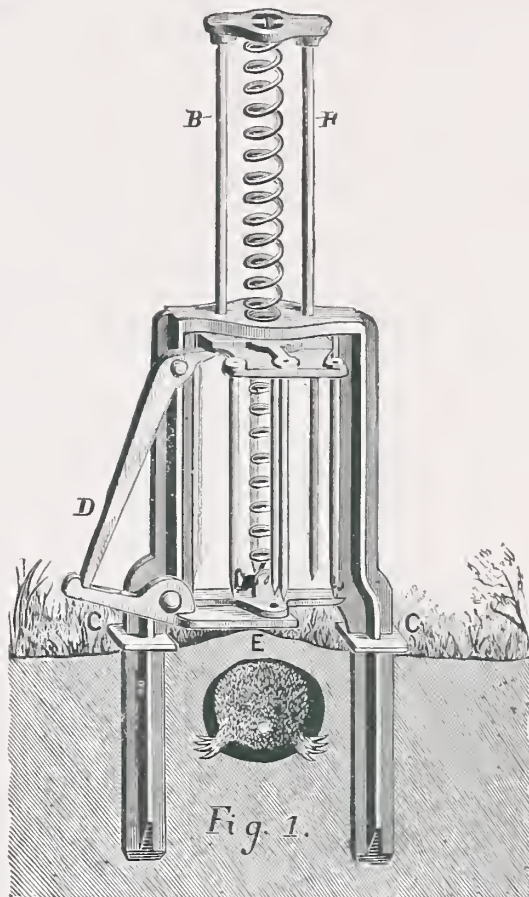

## MOLE TRAPS.

	Each	Per 1/4 Dozen
Olmsteads . . . . .	\$1.50	\$4.20
Perfection . . . . .	2.00	5.70
Model . . . . .	1.50	4.20
"Out O'Sight" . . . . .	1.00	2.70
Hale's . . . . .	2.00	5.70
English . . . . .	.30	.85
Enterprise . . . . .	1.70	4.95

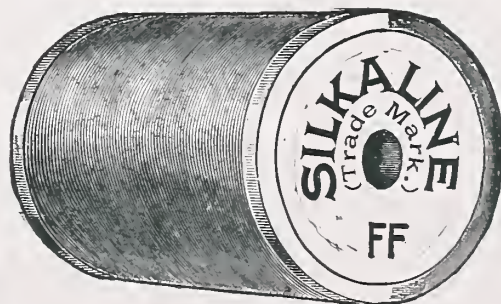

## TYING MATERIALS

**Green Silkaline.** The best material for tying; does not fade; is very strong and durable. 20c. per spool; \$1.50 per lb.

**Raffia.** For tying. 20c. per lb.

**String.** For tying. All sizes. 5c. to 20c. per ball.

## "GEM OF THE GARDEN" Single Wheel Hoe.

Price Complete . . . . . \$4.00

## GEM DOUBLE WHEEL HOE.

Price complete \$5.00

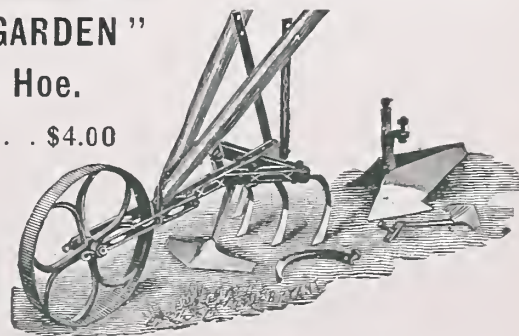

**Sickles or Grass Hooks.** All sizes, 25 cts., 35 cts., 40 cts., 50 cts., 60 cts. and 70 cts. each.

**English Rivet Back Lawn Scythes.** Each \$1.25, \$1.35, \$1.50.

**American Scythes.** 65 cts. each.

**Snathes for Scythes.** 65 cts. each.

**Lawn Border Shears.** Each \$2.50 and \$3.00.

# Michell's Summer Edition, July August 1900.

## WEEDS UTTERLY DESTROYED

FOR FULLY FIVE YEARS BY ONE SINGLE APPLICATION OF

# Fairmount ..Weed \* Killer..

One single dressing done according to our directions will keep **GUTTERS, PATHS and ROADWAYS** clear of Weeds, Poison Ivy, Grasses, Mosses, Dandelions, Burdock, etc., for five full years or more.

It is the most Effectual Weed Killer known, does the work at one-twentieth part of the cost of any other method, and is also far more convenient to use than any other material.

It completely destroys all weeds wherever applied, and by its effect on the ground prevents the growth of fresh ones for five years afterwards, thus saving an immense amount of labor in hoeing, rolling and re-rolling.

FAIRMOUNT WEED KILLER is warranted not injurious to marble, or stonework of any kind, and it leaves the gravel paths and roads clean and bright.

Its application is easy, being in a liquid form, and only requiring to be mixed with water and applied with a watering can or watering cart. Five gallons mixed with two hundred and fifty gallons of water will cover an area of from 500 to 600 square yards, and will make a liquid which will effectually destroy ALL VEGETABLE GROWTHS. Full directions for use with each package.

## LIST OF PRICES.

Net, F. O. B. Philadelphia.

½ gallon tin—makes 25 gallons treating liquid . . . . .	\$ .75
1 gallon tin—makes 50 gallons treating liquid . . . . .	1.25
5 gallon keg—makes 250 gallons treating liquid . . . . .	6.00
10 gallon keg—makes 500 gallons treating liquid . . . . .	11.00
25 gallon cask—makes 1250 gallons treating liquid . . . . .	25.00
50 gallon barrel—makes 2500 gallons treating liquid . . . . .	45.00

### SPECIAL NOTICE.

The price of "Fairmount Weed Killer" should not be compared with cheaper brands offered. By comparing the treating liquid of the Fairmount Weed Killer with cheaper brands you will notice that the Fairmount Weed Killer is by far the cheapest.

We guarantee every drop sold, and will be pleased to show the *test places* in Fairmount Park, treatment made there five years ago and ground is still bare. We have the best and cheapest preparation made. Write for testimonials.

## VAN REYPER'S PERFECT GLAZING POINTS.

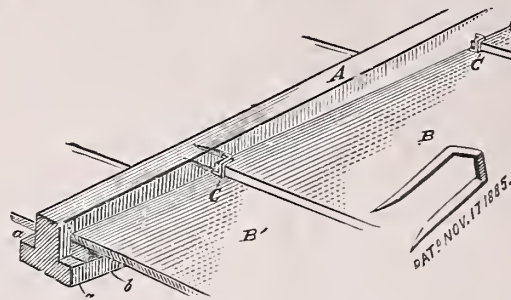

These are made of steel wire and galvanized, having double points and lap over the glass in such a manner as to positively keep it from sliding. They may be used on either side of the sash bar, thus preventing the annoyance of rights and lefts.

Per box of 1000, 60c., 5000 lots at 55c. per 1000. Pincers for driving, 50c.



## MASTICA

### FOR GLAZING GREENHOUSES

(New or Old).

Machines for applying Mastica.

Elastic, adhesive, easy to apply. Used now extensively, and highly recommended by all the up-to-date gardeners and florists. Immense quantities were used last season. Remains in elastic, pliable condition for years, does not become hard.

One gallon will cover about 300 running feet.  
Per gal. \$1.25; half gal. 65c.; 5 gals. \$5.75.  
Machines for applying Mastica, \$1.00 each.

## PUTTY BULBS

USED IN GLAZING FOR APPLYING PUTTY.

Each . . . . . 90 cents.

## RUSTIC WORK.

Made Extra

Strong and Durable.

HANGING BASKETS,  
STANDS,  
CHAIRS and  
SETTEES.

A Large Assortment.



## GRASS EDGING KNIVES.

50 cts. to \$1.50 each.